



Blast Chiller

Instruction manual



EN	Blast Chiller	2
	<u>Instruction manual</u>	
NL	Vriezer	12
	<u>Handleiding</u>	
FR	Congélateurs	22
	<u>Mode d'emploi</u>	

DE	Tiefkühlische	32
	<u>Bedienungsanleitung</u>	
IT	Congelatori	42
	<u>Manuale di istruzioni</u>	
ES	Congeladores	52
	<u>Manual de instrucciones</u>	

Model • Modèle • Modell • Modello • Modelo:
UA014/UA015/UA016

Safety Instructions

- Position on a flat, stable surface.
- A service agent/qualified technician should carry out installation and any repairs if required. Do not remove any components or service panels on this product.
- Consult Local and National Standards to comply with the following:
 - Health and Safety at Work Legislation
 - BS EN Codes of Practice
 - Fire Precautions
 - IEE Wiring Regulations
 - Building Regulations
- DO NOT use jet/pressure washers to clean the appliance.
- DO NOT use the appliance outside.
- DO NOT use this appliance to store medical supplies.
- DO NOT allow oil or fat to come into contact with the plastic components or door seal. Clean immediately if contact occurs.
- Always carry, store and handle the appliance in a vertical position and move by holding the base of the appliance.
- Always switch off and disconnect the power supply to the unit before cleaning.
- Keep all packaging away from children. Dispose of the packaging in accordance with the regulations of local authorities.
- If the power cord is damaged, it must be replaced by a POLAR agent or a recommended qualified technician in order to avoid a hazard.

- This appliance is not intended for use by persons (including children) with reduced physical, sensory or mental capabilities, or lack of experience or knowledge, unless they have been given supervision or instruction concerning the use of the appliance by a person responsible for their safety.
- POLAR recommend that this appliance should be periodically tested (at least annually) by a Competent Person. Testing should include, but not be limited to: Visual Inspection, Polarity Test, Earth Continuity, Insulation Continuity and Functional Testing.
- POLAR recommend that this product is connected to a circuit protected by an appropriate RCD (Residual Current Device).

Caution: Risk of Fire



- Do not store explosive substances such as aerosol cans with a flammable propellant in this appliance.



Warning: Keep all ventilation openings clear of obstruction. Unit should not be boxed in without adequate ventilation.

- **Warning:** Do not use mechanical devices or other means to accelerate the defrosting process, other than those recommended by the manufacturer.
- **Warning:** Do not damage the refrigerant circuit.
- **Warning:** Do not use electrical appliances inside the food storage compartments of the appliance.

Product Description

UA014 - POLAR Blast Chiller with Touch screen Controller (3 x 1/1GN)

UA015 - POLAR Blast Chiller with Touch screen Controller (5 x 1/1GN)

UA016 - POLAR Blast Chiller with Touch screen Controller (10 x 1/1GN)

Introduction

Please take a few moments to carefully read through this manual. Correct maintenance and operation of this machine will provide the best possible performance from your POLAR product.

Pack Contents

The following is included:

- POLAR Blast Chiller
- Instruction manual

POLAR prides itself on quality and service, ensuring that at the time of unpacking the contents are supplied fully functional and free of damage. Should you find any damage as a result of transit, please contact your POLAR dealer immediately.

Installation

Note: Not for use in vans or trailers, food trucks or similar vehicles.

Note: If the unit has not been stored or moved in an upright position, let it stand upright for approximately 12 hours before operation. If in doubt allow to stand.

1. Remove the appliance from the packaging. Make sure that all protective plastic film and coatings are thoroughly removed from all surfaces.
2. To optimize performance and longevity, ensure a minimum clearance of 2.5cm is maintained between the unit and walls and other objects, with a minimum 20cm clearance on the top.
NEVER LOCATE NEXT TO A HEAT SOURCE.

Note: Before using the appliance for the first time, clean the interior with soapy water then dry well.

3. Set the brakes on the castors to keep the appliance in position.

Reversing the door

Depending on the location of the appliance, it may be necessary to change the direction the door opens by changing the side of the door handle.

- Unplug the appliance.
- Should a product issue occur as a result of reversing the door, any repair action required would be chargeable. If you require an engineer to carry out the task, please call a Polar agent.
- For details, please refer to instructions on Pages 62-65.

Operation

Storing Food

To get the best results from your POLAR appliance, follow these instructions:

- It is important that food entering the Blast Chiller/Freezer does not exceed a temperature of 90°C.
- It is recommended that metal containers / trays are used as other materials such as plastic or polystyrene containers will act as an insulator and extend blast chilling times.
- Sufficient space must be left between products in order to guarantee a sufficient flow of cold air. Ensure product is not in contact with the internal walls of the unit, and leave sufficient gaps between trays.
- Never obstruct the inlet of the evaporator fans.
- Products that are more difficult to chill because of their composition and size should be placed in the centre of the unit.
- Blast chilling data refers to standard products (low fat content) with a thickness below 50 mm: therefore avoid overlaying products on trays or the insertion of pieces with a much higher thickness, as this will lead to an extension of blast chilling times. Always distribute the product well on the trays and in the case of thick pieces decrease the amount to blast chill.
- Limit the number of times and the duration of time the doors are opened.
- The chiller should be used for storage for short periods only.
- When removing product that has undergone blast chilling/shock freezing, always wear gloves to protect hands from cold burns.

Insert the food probe

- Before selecting which cycle to use, the probe must be inserted into the food. This allows the internal temperature of the food to be measured.
- It is important that the probe is correctly connected to the unit, or an alarm will activate and the appliance will not function.

Note: To prevent bacterial contamination or contamination of any other biological nature, the needle probe must be disinfected after use.

User interface

Initial information

The interface has the following operating modes:

- **Off:** No power to the device
- **Stand-by:** The device is powered but switched off
- **On:** The device is powered, switched on and awaiting start-up of an operating cycle
- **Run:** The device is powered, switched on and running an operating cycle

Initial switch-on

Connect the appliance to the mains power supply. The appliance will show the loading screen. When loading completed, the display will show:

- the Home screen if pressing the central area in the On/Standby screen
- the Home screen directly

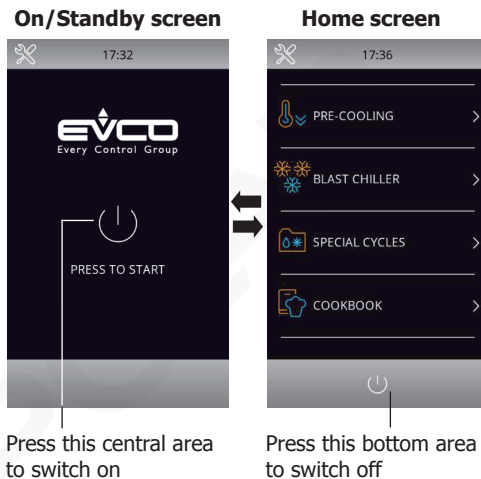

Notes:

- "Switch on the device" means moving from "Stand-by" to "On" mode;
- "Switch off the device" means moving from "On" to "Stand-by" mode.
- If the power supply fails during "stand-by" or "on" mode, when power is restored the device will return to the mode set before the failure.

Note: If the power supply has been cut off long enough to cause a clock error (RTC code), it will be necessary to reset the date and time. The date and time can be set from the settings screen (For details, please see "Section 12.1" in the controller manual supplied with the appliance).

Selecting the screen language

1. While in the Home screen, press the set key  on the left top.

2. The display will show the Setting menu as below:

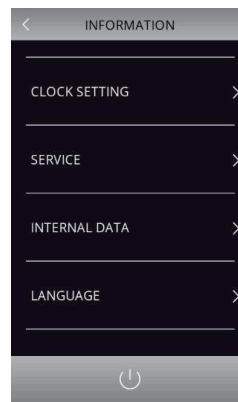

3. Press "LANGUAGE" to display the language menu:
4. Press the desired language to confirm (Note: The default language is English).

Unlock keypad

If the keypad is locked, a menu will pop up when it is touched. Slide the finger rightward to unlock.

Silencing the buzzer

Press any key while buzzer sounding to cease.

Door-open signal

When the door is opened, the signal  will appear on the display. Press any area on the display to remove this signal.





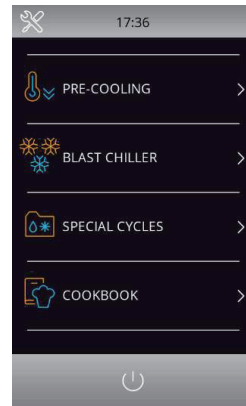

Selecting the operating mode

The operating functions can be accessed from the Home screen by selecting the desired area.

Note:

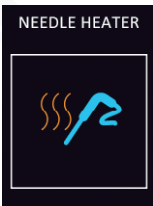
For the use of the appliance, please follow the screen indications for instant operations. Or alternatively you can refer to the controller manual supplier with the appliance for details.



 PRE-COOLING >	<p>Press this area to select a cabinet pre-cooling cycle. (For details, see Section 10 in the controller manual supplied with the appliance.)</p>
 BLAST CHILLER >	<p>Blast chilling mode. Under this mode, you can select/set a standard blast chilling/blast-freezing cycle, a multi-needle probe or multi-timer cycle. (For details, see Section 7 in the controller manual supplied with the appliance.)</p>
 SPECIAL CYCLES >	<div style="display: flex; align-items: center;"> <div style="margin-right: 20px;">  </div> <div style="margin-right: 20px;">  </div> <div style="margin-left: 20px;"> <p>Special cycles mode: Under this mode, only the probe heating function is supported. (For details, see Sections 6.2 and 8.6 in the controller manual supplied with the appliance.)</p> </div> </div>
 COOKBOOK >	<p>Makes it possible to access the recipe book mode, where pre-saved recipes are available for selection. (For details, see Section 9 in the controller manual supplied with the appliance.)</p>
	<p>This area will appear if an alarm is activated.</p>
	<p>Press this area to see the historical data stored during operation. (For details, see Sections 7.6.2 and 12.2 in the controller manual supplied with the appliance.)</p>

Cleaning, Care & Maintenance



Switch off and disconnect from the power supply before cleaning.

- Clean the interior of the appliance as often as possible.
- Do not use abrasive cleaning agents. These can leave harmful residues.
- Clean the door seal with water only.
- Always wipe dry after cleaning.
- Do not allow water used in cleaning to run through the drain hole into the evaporation pan.
- Take care when cleaning the rear of the appliance. Sharp edges can cut.

Condensation will form in refrigeration with frequent opening of the doors and on hot humid days, please ensure condensation is allowed to drain properly or is wiped dry.

Stainless Steel Care

To maintain the stainless steel exterior of your Polar item, please consider the following information:

Never:

- Use abrasive Scourers or scrubbing pads, etc.
- Use Chlorinated or acidic detergents
- Allow anything e.g. food, dirt, cleaning chemicals to remain on the surface for longer than necessary, clean them off right away.
- Allow the surface to remain wet.

Do:

- Clean often.
- Use soft Cloths or plastic Scourers.
- Rub with the grain of the metal, rather than across it.
- Use detergents and polish designed for cleaning Stainless Steel.
- Ensure that the cleaning products are washed off fully and that the steel is left dry.

Cleaning the evaporator

- Clean the evaporator periodically.
- As the fins of the evaporator are very sharp. Always wear protective gloves.
- Only a brush can be used for cleaning. Do not use jets of liquid or sharp instruments.
- To access the evaporator proceed as follows:
 1. Open the door (A) of the appliance.
 2. Loosen the two screws (B) on the right of the deflector.
 3. Remove the runner (C).
 4. Turn the deflector (D) to the left.

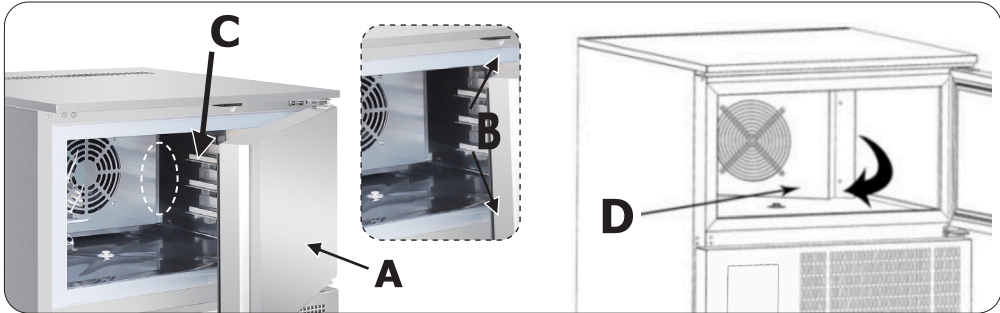

Cleaning the condenser

- Clean the condenser periodically.
- As the fins of the condenser are very sharp, always wear protective gloves.
- Use protective masks and glasses in the presence of dust.
- Whenever the condenser has a deposit of dust in correspondence with the fins, this can be removed using a suction device or with a brush applied, using a vertical movement along the direction of the fins.
- No other instruments must be used, which may deform the fins and therefore the efficiency of the appliance.
- To clean, proceed as follows:
 1. Open the door (A) of the appliances.
 2. Remove the lower panel (B). To do this, remove the screw fasteners (C).
 3. It is now possible to clean the finned part of the condenser (D) using suitable tools and protection devices.
 4. After cleaning, close the control panel and fix it with the screws removed beforehand.

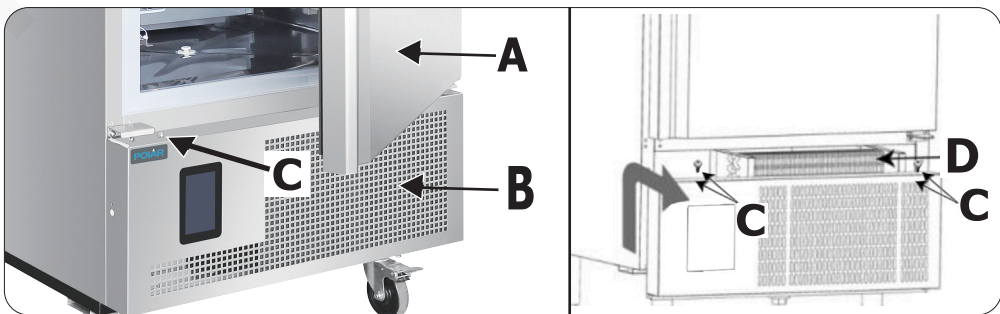

Troubleshooting

A qualified technician must carry out repairs if required.

Fault	Probable Cause	Solution
The appliance is not working	The unit is not switched on	Check the unit is plugged in correctly and switched on
	Plug or lead is damaged	Replace plug or lead
	Fuse in the plug has blown	Replace the fuse
	Mains power supply fault	Check mains power supply
The appliance is leaking water	The appliance is not properly levelled	Adjust the screw feet to level the appliance (if applicable)
	The drain is blocked	Clear the discharge outlet
	Movement of water to the drain is obstructed	Clear the floor of the appliance (if applicable)
	The water container is damaged	Consult a qualified technician
The appliance is unusually loud	The appliance has not been installed in a level or stable position	Check installation position and change if necessary
	Loose nut/screw	Check and tighten all nuts and screws
The appliance is not chilling	Wrong program	Change program - see controller manual
	The filter is blocked	Clean filters
Temperature of food is not being detected	The food probe is broken	Purchase a new food probe from your Distributor
Food has freezer burns after removing from unit	The selected cycle is not suitable for the food	Change cycle from hard freeze to soft freeze (→ Selecting the operating mode)
The appliance is beeping and there is a message appearing on the control panel	There is a problem with the unit being indicated by the control alarm signal	See table below

Control panel message/code	Meaning	Required action
RTC	Clock error	Re-set date and time. For details, see "Section 12.1: Service" in the controller manual supplied with the appliance
CABINET PROBE	Cabinet probe error	<ul style="list-style-type: none"> Check that the probe is undamaged Check the device-probe connection Check the cabinet temperature If problem persists, Call POLAR agent or qualified technician.
EVAPORATOR PROBE	Evaporator probe error	Same as for the cabinet probe error but with reference to the evaporator probe
CONDENSER PROBE	Condenser probe error	Same as for the cabinet probe error but with reference to the condenser probe
NEEDLE PROBE SENSOR 1/2/3	Needle probe/sensor 1/2/3 error	Same as for the cabinet probe error but with reference to needle probe 1/2/3
NEEDLE PROBE	Needle probe alarm (all the needle probe sensors enabled are in alarm status)	Same as for the cabinet probe error but with reference to all the needle probes
NEEDLE PROBE INSERTION	Needle probe not inserted alarm	Check that the needle probes have been correctly inserted
DOOR OPEN	Door open alarm	Check the door status
HIGH TEMPERATURE	Maximum temperature alarm (HACCP alarm)	<ul style="list-style-type: none"> Check the cabinet temperature
LOW TEMPERATURE	Minimum temperature alarm (HACCP alarm)	<ul style="list-style-type: none"> Check the cabinet temperature
POWER FAILURE	Power failure alarm (HACCP alarm)	Check the device-power supply connection

Note: This table just lists very basic alarms. For more detailed alarm information, please see "Section 16 Alarms" in the controller manual.

Technical Specifications

Note: Due to our continuous improvement process, the product specifications are subject to change without notice.

Model	Voltage	Power	Capacity	Weight (kg)	Temperature range	Refrigerant	Dimensions H x W x D
UA014	230V~ 50Hz	700W	3 x GN1/1	104	+5°C ~ -35°C	R290	965 x 804 x 826
UA015		720W	5 x GN1/1	116	+5°C ~ -35°C	R290	1035 x 804 x 826
UA016		900W	10 x GN1/1	150	+5°C ~ -35°C	R290	1885 x 800 x 815

Model	Chill Rate	Freeze Rate	Chiller full load capacity	Freezer full load capacity
UA014	90 min (12kg)	240 min (8kg)	12kg	8kg
UA015	90 min (18kg)	240 min (14kg)	18kg	14kg
UA016	90 min (40kg)	240 min (28kg)	40kg	28kg

Electrical Wiring

POLAR appliances are supplied with a 3 pin BS1363 plug and lead.

The plug is to be connected to a suitable mains socket.

POLAR appliances are wired as follows:

- Live wire (coloured brown) to terminal marked L
- Neutral wire (coloured blue) to terminal marked N
- Earth wire (coloured green/yellow) to terminal marked E

The appliances must be earthed.



If in doubt consult a qualified electrician.

Electrical isolation points must be kept clear of any obstructions. In the event of any emergency disconnection being required they must be readily accessible.

Disposal

EU regulations require refrigeration product to be disposed of by specialist companies who remove or recycle all gasses, metal and plastic components.

Consult your local waste collection authority regarding disposal of your appliance. Local authorities are not obliged to dispose of commercial refrigeration equipment but may be able to offer advice on how to dispose of the equipment locally.

Alternatively call the POLAR helpline for details of national disposal companies within the EU.

Compliance

The WEEE logo on this product or its documentation indicates that the product must not be disposed of as household waste. To help prevent possible harm to human health and/or the environment, the product must be disposed of in an approved and environmentally safe recycling process. For further information on how to dispose of this product correctly, contact the product supplier, or the local authority responsible for waste disposal in your area.



POLAR parts have undergone strict product testing in order to comply with regulatory standards and specifications set by international, independent, and federal authorities.

POLAR products have been approved to carry the following symbol:



All rights reserved. No part of these instructions may be produced or transmitted in any form or by any means, electronic, mechanical, photocopying, recording or otherwise, without the prior written permission of POLAR.

Every effort is made to ensure all details are correct at the time of going to press, however, POLAR reserve the right to change specifications without notice.

Veiligheidstips

- Plaatsen op een vlakke en stabiele ondergrond.
- De installatie en eventuele reparaties dienen door een servicemonteur/vakman uitgevoerd te worden. Verwijder geen onderdelen of servicepanelen van dit product.
- Raadpleeg en volg de plaatselijke en nationale regelgeving op m.b.t. tot het volgende:
 - Wetgeving inzake gezondheid en veiligheid op het werk
 - NEN-praktijkrichtlijnen
 - Brandpreventie
 - IEE-bedradingsvoorschriften
 - Bouwvoorschriften
- Dit product NIET reinigen met spuit-/drukreinigers.
- Uitsluitend geschikt voor gebruik binnenshuis.
- Dit product NIET gebruiken voor de berging van medische producten.
- Laat NIET toe dat olie of vet in contact komt met plastic componenten of deurafdichtingen. Onmiddellijk reinigen indien dit wel gebeurt.
- Dit product altijd in een verticale positie vervoeren, opbergen en gebruiken. Het product aan de kastbasis vervoeren.
- Alvorens dit product te reinigen dient men altijd de stroomvoorziening uit te schakelen.
- Laat verpakkingsmateriaal niet binnen handbereik van kinderen. Verpakkingsmateriaal in overeenstemming met de regelgeving van de plaatselijke overheden als afval laten verwerken.
- Indien de stroomkabel beschadigd raakt, dient men deze door een POLAR technicus of een aanbevolen vaktechnicus te laten vervangen om gevaarlijke situaties te verhinderen.

- Dit apparaat is niet bedoeld voor gebruik door personen met lichamelijke, zintuiglijke of mentale beperkingen (inclusief kinderen) of met gebrek aan ervaring of kennis tenzij zij hierin worden begeleid of zijn opgeleid in het gebruik van het apparaat door een persoon, die verantwoordelijk is voor hun veiligheid.
- POLAR beveelt aan dat dit apparaat periodiek (minstens jaarlijks) door een bevoegde persoon wordt getest. Tests moeten omvatten, maar zijn niet beperkt tot: visuele inspectie, polariteit, aardings continuïteit, isolatie continuïteit en functionele test.

Voorzichtig brandgevaar



- Heeft explosieve stoffen zoals spuitbussen niet slaan met een brandbaar drijfgas in dit apparaat.



Waarschuwing: Hou alle ventilatieopeningen vrij van obstakels. Het apparaat mag niet ingesloten worden zonder adequate ventilatie.

- **Waarschuwing:** gebruikt geen mechanische apparaten of andere middelen om het ontdooien te versnellen, anders dan welke aanbevolen worden door de fabrikant.
- **Waarschuwing:** het koelcircuit niet beschadigen.
- **Waarschuwing:** Gebruik geen elektrische apparaten in de bewaarruimte voor voedsel van het apparaat.

Productbeschrijving

UA014 - POLAR Vriezer met touchscreen bediening (3 x 1/1GN)

UA015 - POLAR Vriezer met touchscreen bediening (5 x 1/1GN)

UA016 - POLAR Vriezer met touchscreen bediening (10 x 1/1GN)

Inleiding

Neem de tijd om deze handleiding aandachtig door te lezen. Met het correcte gebruik en onderhoud levert dit product van POLAR de beste resultaten op.

Verpakkingsinhoud

De verpakking bevat het volgende:
POLAR Vrieskast

Handleiding

POLAR is trots op de haar productkwaliteit en dienstverlening en controleer de inhoud van de verpakkingen, tijdens de verpakkingfase, op functioneren en schade. Mocht uw product door transport zijn beschadigd, neem dan onmiddellijk contact op met uw POLAR-dealer.

Installatie

Opmerking: Niet voor gebruik in bestelwagens of aanhangwagens, foodtrucks of soortgelijke voertuigen.

Opmerking: indien het apparaat niet in een rechtopstaande positie is opgeslagen of vervoerd, dient men het product 12 uur vóór gebruik in de rechtopstaande positie te plaatsen. Bij twijfel dient men het product in een rechtopstaande positie te plaatsen.

1. Haal het product uit de verpakking. Zorg ervoor dat u de beschermingsfolie en -lagen van alle oppervlakken heeft verwijderd.
2. Om de prestaties en levensduur te optimaliseren, dient u ervoor te zorgen dat er minimaal 2,5 cm afstand wordt gehouden tussen de unit en muren en andere objecten, met een minimale vrije ruimte van 20 cm aan de bovenkant. **PLAATS NOOIT NAAST EEN WARMTEBRON.**

Opmerking: Voordat u het apparaat voor de eerste keer gebruikt, reinigt u het interieur met een sopje en droogt u het vervolgens goed af.

3. Zet de remmen van de wieltjes om het product op zij plaats vast te zetten.

Omkeren van de deur

Afhankelijk van de locatie van het apparaat, kan het nodig zijn om de richting waarin de deur opent te veranderen door de zijkant van de deurkruk te veranderen.

- Haal de stekker uit het stopcontact.
- Mocht er een probleem met het product optreden als gevolg van het omkeren van de deur, dan worden eventuele reparatiemaatregelen in rekening gebracht. Als u een monteur nodig heeft om de taak uit te voeren, neem dan contact op met een vertegenwoordiger van Polar.
- Raadpleeg de instructies op pagina's 62-65.

Bediening

Opslag van levensmiddelen

Volg de volgende aanwijzingen voor de beste resultaten met uw POLAR product:

- Het is belangrijk dat het voedsel dat in de Blast koel-/vrieskast wordt geplaatst, niet warmer is dan 90°C.
- Het wordt aanbevolen om metalen containers/trays te gebruiken aangezien andere materialen zoals plastic of polystyreen containers als een isolator dienst doen en de koel/vriestijden verlengen.
- Er moet voldoende ruimte voorzien worden tussen de producten zodat een voldoende stroom van koude lucht wordt voorzien. Zorg dat het product niet in contact komt met de interne wanden van het toestel en voorzie voldoende ruimte tussen de trays.
- U mag de inlaat van de verdamperventilatoren nooit belemmeren.
- Producten die omwille van hun samenstelling en omvang moeilijker af te koelen zijn, moeten in het midden van het toestel geplaatst worden.
- De data voor koelen/vriezen verwijzen naar standaardproducten (laag vetgehalte) van minder dan 50 mm dik: daarom dient men te vermijden om producten boven elkaar te plaatsen op trays of veel dikkere stukken te plaatsen, aangezien dit de koel-/vriestijden zal verlengen. U dient het product steeds goed te verdelen over de trays en in het geval van dikke stukken dient u het te koelen/vriezen volume te verminderen.
- Beperk het aantal keren en de tijd dat de deuren worden geopend.
- De koelkast mag uitsluitend voor korte bewaarperioden gebruikt worden.
- Wanneer een product wordt verwijderd dat koelen-vriezen/shockvriezen heeft ondergaan, dient u steeds handschoenen te dragen om de handen te beschermen tegen koude brandwonden.

Plaatsen de kern thermometer

- Alvorens het kiezen van de cyclus, moet de sonde in het voedsel ingebracht worden. Hierdoor kan de interne temperatuur van het voedsel gemeten worden.
- Het is belangrijk dat de sonde correct is aangesloten op de eenheid, anders wordt er een alarm geactiveerd en zal het toestel niet functioneren.

Opmerking: Om bacteriële besmetting of contaminatie van elke andere biologische aard te voorkomen moet de naaldsonde gedesinfecteerd worden na ieder gebruik.

Gebruikersinterface

Eerste informatie

De interface heeft de volgende bedrijfsmodi:

- **Uit:** Geen stroom naar het apparaat.
- **Stand-by:** Het apparaat wordt van stroom voorzien, maar is uitgeschakeld
- **Aan:** Het apparaat krijgt stroom, wordt ingeschakeld en wacht op het opstarten van een bedrijfscyclus
- **Lopen:** Het apparaat wordt van stroom voorzien, is ingeschakeld en voert een bedrijfscyclus uit

Eerste inschakeling

Sluit het apparaat aan op het elektriciteitsnet. Het apparaat geeft het laadscherm weer. Als het laden is afgerond, toont het beeldscherm:

- het startscherm als u op het middelste gedeelte van het aan/ stand-by scherm drukt
- het startscherm meteen

Aan/ stand-by scherm

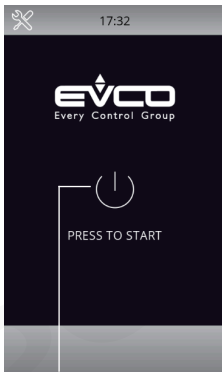

Druk op dit onderste gedeelte om in te schakelen

Startscherm

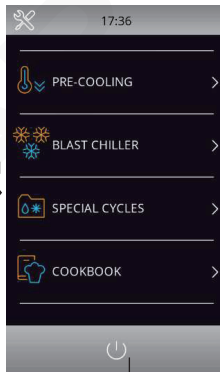

Druk op dit middelste gedeelte om in te schakelen

Toelichtingen:

- "Het apparaat inschakelen" betekent van "Stand-by" naar "Aan" modus schakelen;
- "Het Apparaat uitschakelen" betekent van "Aan" naar "Stand-by" modus schakelen.
- Als de stroomvoorziening uitvalt tijdens de "Stand-by" of "Aan" modus, zal het apparaat na het herstellen van de stroomvoorziening terugkeren naar de modus, die was ingesteld vóór de storing.

Toelichting: Als de stroomvoorziening lang genoeg onderbroken is geweest om een klokfout (RTC-code) te veroorzaken, is het noodzakelijk dat de datum en tijd opnieuw worden ingesteld. De datum en tijd kunnen worden ingesteld via de instellingen van het beeldscherm (Zie "Paragraaf 12.1" in de bedieningshandleiding, die bij het apparaat is meegeleverd, voor meer informatie).

De beeldschermtaal selecteren

1. Druk in het startscherm op de insteltoets  linksboven aan.
2. Het beeldscherm geeft het instellingenmenu weer, zoals hieronder:

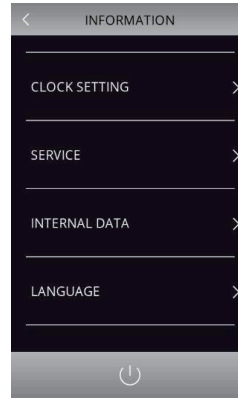

3. Druk op "TAAL" om het taalmenu weer te geven:
4. Druk op de gewenste taal om het te bevestigen (Opmerking: De standaardtaal is Engels).

Het toetsenbord ontgrendelen

Als het toetsenbord is vergrendeld, verschijnt er een menu wanneer het wordt aangeraakt. Schuif de vinger naar rechts om te ontgrendelen.

De zoemer uitschakelen

Druk op een willekeurige toets, terwijl de zoemer afgaat, om het te stoppen

Deur-open signaal

Wanneer de deur wordt geopend, verschijnt het signaal  op het beeldscherm. Druk op een willekeurige plaats op het beeldscherm om dit signaal te verwijderen.







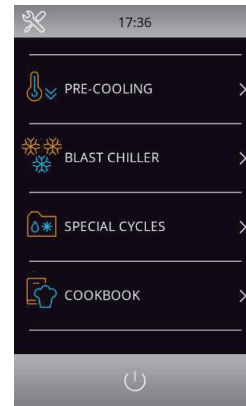

De bedieningsmodus selecteren

De bedieningsfuncties kunnen vanaf het startscherm worden opgeroepen door het gewenste gedeelte te selecteren.

Toelichting:

Voor het gebruik van het apparaat, gelieve volg de aanwijzingen op het beeldscherm voor onmiddellijke werking. U kunt ook de bedieningshandleiding raadplegen, die bij het apparaat is meegeleverd.



 PRE-COOLING >	<p>Druk op dit gebied om een voorkoeling cyclus voor de vriezer-kabinet te selecteren. (Zie paragraaf 10 in de bedieningshandleiding, die bij het apparaat is meegeleverd, voor meer informatie).</p>
 BLAST CHILLER >	<p>Snelkoelen modus. In deze modus kunt u een standaard snelkoel- / snelvriescyclus, een multi-naaldsonde of multi-timer cyclus selecteren / instellen. (Zie paragraaf 7 in de bedieningshandleiding, die bij het apparaat is meegeleverd, voor meer informatie).</p>
 SPECIAL CYCLES >	<div style="display: flex; align-items: center;"> <div style="margin-right: 20px;">  </div> <div style="margin-right: 20px;">  </div> </div> <p>Speciale cycli modus: In deze modus wordt alleen de verwarmingsfunctie van de ondersteund. (Zie paragrafen 6.2 en 8.6 in de bedieningshandleiding van de thermostaat, die bij het apparaat is meegeleverd, voor meer informatie.)</p>
 COOKBOOK >	<p>Maakt het mogelijk toegang te krijgen tot de receptenboek modus, waarin vooraf opgeslagen recepten kunnen worden geselecteerd. (Zie paragraaf 9 in de bedieningshandleiding, die bij het apparaat is meegeleverd, voor meer informatie.)</p>
	<p>Dit gebied verschijnt als een alarm is geactiveerd.</p>
	<p>Druk op dit gebied om de historische gegevens te zien die tijdens het gebruik zijn opgeslagen. (Zie paragrafen 7.6.2 en 12.2 in de bedieningshandleiding, die bij het apparaat is geleverd, voor meer informatie.)</p>

Reiniging, zorg & onderhoud



Alvorens het apparaat te reinigen dient men de stroomvoorziening uit te schakelen.

- Reinig zo vaak mogelijk de binnenkant van het product.
- Gebruik géén schurende reinigingsmiddelen. Dergelijke middelen kunnen schadelijke resten achterlaten.
- Reinig de deurafdichting uitsluitend met water.
- Na reiniging altijd droogmaken.
- Het voor reiniging gebruikte water mag niet door het afvoergat naar de verdampingspan stromen.
- Ga voorzichtig te werk bij het reinigen van de achterzijde van het product. Scherpe randen kunnen snijwonden veroorzaken.

Bij het regelmatig openen van de deuren in de koelkast vormt zich condensatie. Zorg er op warme, vochtige dagen voor dat het condenswater goed kan weglopen of drooggeveegd wordt.

Verzorging van roestvrij staal

De volgende informatie betreft het onderhoud van de roestvrijstalen buitenkant van het Polar product.

Nooit:

- schurende blokjes of sponsjes etc. gebruiken;
- reinigingsmiddelen met chloor of zuur gebruiken;
- toelaten dat voedsel, vuil, chemische reinigingsmiddelen enz. langer dan nodig op het oppervlak achterblijven - verwijder ze onmiddellijk;
- toelaten dat het oppervlak nat blijft.

Wel:

- vaak schoonmaken;
- zachte doeken en plastic sponsjes gebruiken;
- met de draad van het metaal mee wrijven, in plaats van tegen de draad in;
- reinigings- en poetsmiddelen gebruiken die speciaal voor roestvrij staal zijn bedoeld;
- ervoor zorgen dat de reinigingsproducten volledig worden afgespoeld en dat het staal droog achter blijft.

Schoonmaken van de verdamper

- Reinig de verdamper periodiek.
- Draag altijd beschermende handschoenen aangezien de vinnen van de verdamper zeer scherp zijn.
- Slechts een zachte borstel kan worden gebruikt voor het reinigen. Gebruik geen harde stralen van vloeistoffen of scherpe instrumenten.
- Doe het volgende om toegang te krijgen tot de verdamper:
 1. Open de deur (A) van het apparaat.
 2. Draai de twee schroeven (B) aan de rechterkant van de beschermkap los.
 3. Verwijder de geleiders (C).
 4. Draai de beschermkap (D) naar links.

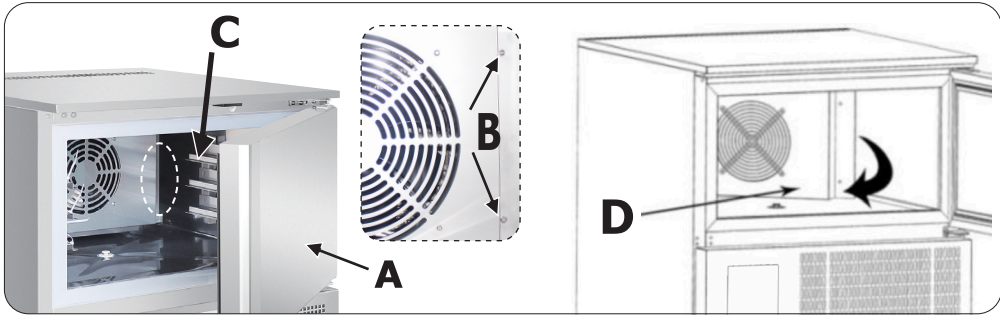

Schoonmaken van de condensor

- Maak de condensor periodiek.
- Draag altijd beschermende handschoenen aangezien de vinnen van de condensor zeer scherp zijn.
- Gebruik beschermende maskers en een bril bij de aanwezigheid van stof.
- Wanneer de condensor een stof-ophoping heeft t.o.v. de vinnen, kan dit worden verwijderd met bv. een stofzuiger of met een kwast; ga dan met een verticale beweging in de lijn van de vinnen.
- Gebruik geen andere voorwerpen, die de vinnen en derhalve de efficiëntie van het apparaat kunnen vervormen.
- Ga als volgt te werk om te reinigen:
 1. Open de deur (A) van het apparaat.
 2. Verwijder het onderste paneel (B). Om dit te doen, verwijdert u de schroeven (C).
 3. Het is nu mogelijk om de vinnen van de condensor (D) met geschikt gereedschap en beveiliging te reinigen.
 4. Na het reinigen; sluit het bedieningspaneel en bevestig het met de schroeven die hiervoor werden verwijderd.

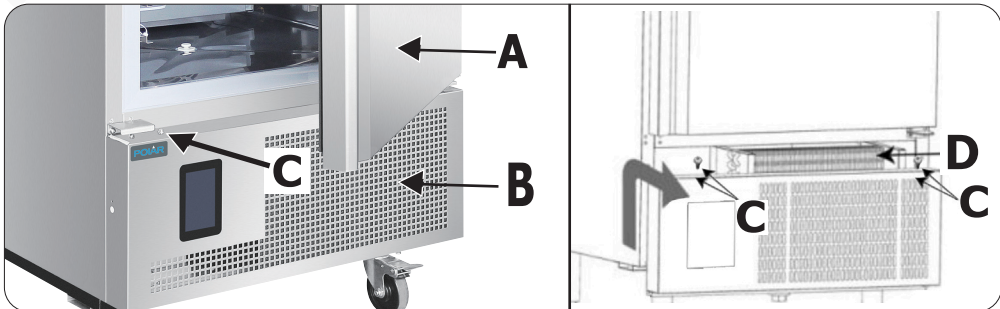

Oplossen van problemen

Indien nodig moet een gekwalificeerde technicus reparaties uitvoeren.

Probleem	Mogelijke oorzaak	Handeling
Het apparaat werkt niet	Het apparaat staat uit	Controleer of de stroomkabel van het apparaat is aangesloten en of het apparaat is ingeschakeld
	Stekker en kabel zijn beschadigd	Vervang stekker of kabel
	Storing netvoeding	Controleer netvoeding
Het toestel lekt water	Het apparaat staat niet goed waterpas	Stel de voetjes van het apparaat bij (indien van toepassing)
	De afvoer is geblokkeerd	Ontruim en deblokkeer de afvoer-uitlaat
	Beweging van water naar de afvoer wordt belemmerd	Ontruim de bodem van het apparaat (indien van toepassing) en maak schoon
	Het waterreservoir is beschadigd	Raadpleeg een gekwalificeerde technicus
Het apparaat maakt veel lawaai	Het apparaat is niet waterpas of op een stabiele positie geïnstalleerd	Controleer de installatie-positie en wijzig indien nodig
	Losse moer/schroef	Controleer en draai alle bouten en moeren aan
Het apparaat koelt en/of vriest niet	Een verkeerd programma?	Wijzig programma - zie bedieningshandleiding
	De filter is geblokkeerd	Reinig de filters
De temperatuur van het voedsel niet wordt gedetecteerd	De kerntemperatuursonde is stuk	Koop een nieuwe kerntemperatuursonde bij uw verdeler.
Eten heeft vriesbrand na het verwijderen uit het toestel	De geselecteerde cyclus is niet geschikt voor het eten	Wijzig cyclus van hard vriezen naar zacht vriezen (→ Een cyclus selecteren)
Het apparaat piept en er verschijnt een boodschap op het bedieningspaneel	Er is een probleem met het apparaat wat wordt aangegeven door het controle alarmsignaal	Zie onderstaande tabel

Bericht op het bedieningspaneel	Betekenis	Vereiste actie
RTC	Clock error klokfout	Stel de datum en tijd opnieuw in. Zie "Paragraaf 12.1: Service" in de bedieningshandleiding, die bij het apparaat is meegeleverd, voor meer informatie
VRIEZER-KABINETSONDE	Vriezer-cabinet fout	<ul style="list-style-type: none"> Controleer of de sonde niet beschadigd is Controleer de verbinding tussen het apparaat en de sonde Controleer de vriezer-kabinet temperatuur Als het probleem aanhoudt, bel dan de POLAR-agent of een gekwalificeerde monteur
VERDAMPERSONDE	Verdampersonde fout	Hetzelfde geldt als voor de fout in de vriezer-kabinetsonde, maar met verwijzing naar de verdamper
CONDENSORSONDE	Condensorsonde fout	Hetzelfde geldt als voor de vriezer-kabinetsonde, maar met verwijzing naar de condensorsonde
NAALDSONDE SENSOR 1/2/3	Naaldsonde/sensor 1/2/3 fout	Hetzelfde geldt als voor de fout in de vriezer-kabinetsonde, maar met verwijzing naar de naaldsonde 1/2/3
NAALDSONDE	Naaldsonde alarm (alle ingeschakelde naaldsondesensoren zijn in alarmstatus)	Hetzelfde geldt als voor de vriezer-kabinetsonde, maar met verwijzing naar alle naaldsondes
PLAATSEN VAN DE NAALDSONDE	Alarm naaldsonde niet geplaatst	Controleer of de naaldsondes juist zijn geplaatst
DEUR OPEN	Deur-open alarm	Controleer de temperatuur van de deurstatus
HOGE TEMPERATUUR	Maximum temperatuuralarm (HACCP-alarm)	Controleer de temperatuur van de vriezer-kabinet
LAGE TEMPERATUUR	Minimum temperatuuralarm (HACCP-alarm)	Controleer de temperatuur van de vriezer-kabinet
STROOMSTORING	Stroomstoring alarm (HACCP alarm)	Controleer de aansluiting van het apparaat op het elektriciteitsnet
Toelichting: In deze tabel staan alleen de basisalarmen. Voor meer gedetailleerde alarminformatie, zie "Paragraaf 16 Alarmen" in de bedieningshandleiding.		

Technische Specificaties

Opmerking: Vanwege ons voortdurende verbeteringsproces, kunnen de productspecificaties zonder voorafgaande kennisgeving worden gewijzigd.

Model	Voltage	Vermogen	Capaciteit	Gewicht (kg)	Temperatuur-bereik	Koel-middel	Afmetingen h x b x d mm
UA014	230V~ 50Hz	700W	3 x GN1/1	104	+5°C ~ -35°C	R290	965 x 804 x 826
UA015		720W	5 x GN1/1	116	+5°C ~ -35°C	R290	1035 x 804 x 826
UA016		900W	10 x GN1/1	150	+5°C ~ -35°C	R290	1885 x 800 x 815

Model	Koeltempo	Snelheid vriezer	Koelvermogen bij volle belasting	Volledige capaciteit vriezer
UA014	90 min. (12kg)	240 min. (8kg)	12kg	8kg
UA015	90 min. (18kg)	240 min. (14kg)	18kg	14kg
UA016	90 min. (40kg)	240 min. (28kg)	40kg	28kg

Elektrische bedrading

Men dient de stekker op een geschikt stopcontact aan te sluiten.

De bedrading van dit apparaat is als volgt:

- Stroomkabel (bruin) naar de aansluitklem gemarkeerd met L
- Neutraalkabel (blauw) naar de aansluitklem gemarkeerd met N
- Aardkabel (groen/geel) naar de aansluitklem gemarkeerd met E

Dit apparaat moet worden geaard.



Bij twijfels raadpleeg een vakkundige electricien.

De elektrische isolatiepunten mogen niet worden geblokkeerd. In geval van een nooduitschakeling moeten de isolatiepunten direct toegankelijk zijn.

Afvalverwerking

De EU-richtlijnen vereisen dat koelproducten door gespecialiseerde bedrijven wordt verwerkt die gassen, metalen en plastic componenten verwijderen of recyclen.

Raadpleeg uw plaatselijke afvalverwerkingsbedrijf voor informatie over de afvalverwerking van uw apparaat. De plaatselijke overheden zijn niet verplicht om koelingsproducten van bedrijven als afval te verwerken maar kunnen uw informeren waar u het apparaat kunt afgeven.

U kunt ook de Polar helpline bellen voor informatie over landelijke afvalverwerkingsbedrijven in de EU.

Productconformiteit

Het WEEE-logo op dit product of bijbehorende documentatie geeft aan dat het product niet onder huisvuil valt en als zodanig ook niet mag worden verwerkt. Ter preventie van mogelijke gevaren voor de gezondheid van personen en/of voor het milieu, dient men dit product in overeenstemming met het voorgeschreven en milieuvriendelijke recyclingproces als afval te verwerken. Raadpleeg uw productleverancier of uw plaatselijk afvalverwerkingsbedrijf voor meer informatie over de juiste afvalverwerking van dit product.



De onderdelen van Polar producten hebben strenge producttesten ondergaan om te voldoen aan wettelijke regels en specificaties die door internationale, onafhankelijke en landelijke overheden worden voorgeschreven.



Polar producten zijn goedgekeurd en voorzien van het volgende symbool:

Alle rechten voorbehouden. Het is verboden om deze handleiding, hetzij volledig of gedeeltelijk, elektronisch of mechanisch te reproduceren, kopiëren, op opslagmedia op te slaan of op enigerlei wijze over te dragen, zonder voorafgaande goedkeuring van Polar.

Wij hebben er alles aan gedaan om er zeker van te zijn dat op publicatiedatum van de handleiding alle details correct zijn, desondanks, behoudt Polar het recht voor om specificaties zonder aankondiging te wijzigen.

Conseils de sécurité

- Placez l'appareil sur une surface plane, stable.
- L'installation et les éventuelles réparations doivent être confiées à un dépanneur / technicien qualifié. Ne retirez aucun composant ou cache de ce produit.
- Consultez les normes locales et nationales pour vous conformer aux :
 - lois sur l'hygiène et la sécurité au travail ;
 - codes de bonnes pratiques BS EN ;
 - précautions contre le risque d'incendie ;
 - réglementations sur les branchements électriques IEE ;
 - règlements sur la construction.
- NE PAS nettoyer cet appareil avec un nettoyeur à jet / à pression.
- Cet appareil est réservé exclusivement à une utilisation à l'intérieur.
- NE PAS se servir de cet appareil pour stocker des médicaments.
- NE PAS éclabousser les composants en plastique ou les joints de porte d'huile ou de matières grasses. En cas d'éclaboussure, nettoyez immédiatement la surface touchée.
- Veillez à toujours transporter, stocker et manipuler l'appareil à la verticale et à le déplacer en tenant la base du châssis.
- N'oubliez jamais d'éteindre et de débrancher l'appareil avant de procéder à son nettoyage.
- Gardez les emballages hors de portée des enfants. Débarrassez-vous des emballages conformément aux règlements des autorités locales.
- Un cordon d'alimentation endommagé doit être remplacé par un agent POLAR ou un technicien qualifié recommandé, pour éviter tout danger.

- Cet appareil n'a pas été conçu pour être utilisé par des personnes (enfants inclus) à capacités physiques, sensorielles ou mentales réduites ou ne disposant pas d'une expérience ou de connaissances suffisantes, à moins que lesdites personnes n'aient été formées ou instruites quant à son utilisation, par une personne responsable de leur sécurité.
- Polar recommande de faire tester régulièrement cet appareil (une fois par an au minimum) par une personne compétente. Le test devrait inclure, entre autres : inspection visuelle, test de polarité, la continuité de masse, test d'isolation et test de fonctionnement.



Attention : Risque d'incendie

- Ne stockez pas de substances explosives telles que les aérosols avec un propulseur inflammable dans cet appareil.



Attention : Évitez de bloquer toutes les ouvertures d'aération. L'unité ne doit pas être mise dans un box dans aération adéquate.

- **Attention :** Ne pas utiliser de dispositifs mécaniques ou autres moyens pour accélérer le processus de dégivrage, autre que le fabricant recommandé Ceux par.
- **Attention :** Ne pas endommager le circuit frigorifique.
- **Attention :** Ne pas utiliser d'appareils électriques à l'intérieur des compartiments de stockage des aliments de l'appareil.

Description du produit

UA014 - Refroidisseur POLAR Blast avec contrôleur à écran tactile (3 x 1/1GN)

UA015 - Refroidisseur POLAR Blast avec contrôleur à écran tactile (5 x 1/1GN)

UA016 - Refroidisseur POLAR Blast avec contrôleur à écran tactile (10 x 1/1GN)

Introduction

Nous vous invitons à consacrer quelques instants à la lecture attentive de ce mode d'emploi. L'entretien et l'utilisation appropriés de cette machine vous permettront de tirer le meilleur de votre produit POLAR.

Contenu de l'emballage

Les éléments suivants vous sont fournis de série :
 Refroidisseur / congélateur rapide POLAR

Mode d'emploi

POLAR attache une grande importance à la qualité et au service et veille à fournir des produits en parfait état opérationnel, parfaitement intacts au moment de l'emballage.

Nous vous prions de contacter votre revendeur POLAR immédiatement si vous constatez un dommage quelconque survenu pendant le transport du produit.

Installation

Ne pas utiliser dans des camionnettes ou des semi-remorques, dans des camions-restaurants ou véhicules similaires.

Remarque : Dans les cas où l'appareil a été stocké ou déplacé autrement que dans la position d'utilisation, attendre 12 heures avant de vous en servir. En cas de doute, laissez l'appareil se reposer.

1. Sortez l'appareil de l'emballage. Veillez à bien retirer toute la pellicule et les revêtements de protection de toutes les surfaces.
2. Pour optimiser les performances et la longévité, assurez-vous qu'un dégagement minimum de 2,5 cm est maintenu entre l'unité et les murs et autres objets, avec un dégagement minimum de 20 cm sur le dessus. **NE JAMAIS PLACER À PROXIMITÉ D'UNE SOURCE DE CHALEUR.**

Remarque : Avant d'utiliser l'appareil pour la première fois, nettoyez l'intérieur à l'eau savonneuse puis séchez-le bien.

3. Bloquez les freins des roulettes de l'appareil, pour l'empêcher de bouger.

Inversion de la porte

En fonction de l'emplacement de l'appareil, il peut être nécessaire de modifier l'ouverture de la porte en changeant le côté d'ouverture de la porte en changeant le côté de la poignée de la porte.

- Débranchez l'appareil.
- Si un accident survient suite à l'inversion de la porte, toute action de réparation nécessaire sera facturée. Si vous avez besoin d'un ingénieur pour effectuer la tâche, veuillez appeler un agent Polar.
- Pour plus de détails, veuillez-vous reporter aux instructions contenues dans les pages 62-65.

Fonctionnement

Stockage des aliments

Suivez ces consignes pour profiter au mieux de votre appareil POLAR :

- Il est important que la température des aliments placés dans le refroidisseur / congélateur rapide n'excède pas 90°C.
- Il est recommandé d'utiliser des conteneurs / plateaux métalliques, car tout autre matériau, tel que le plastique ou le polystyrène, fera office d'isolant et prolongera le temps de réfrigération.
- Il faut laisser un espace suffisant entre les produits afin de garantir une circulation efficace de l'air froid. Veiller à ce que les produits ne soient pas en contact avec les parois intérieures de l'appareil et à laisser un espace suffisant entre les plateaux.
- Ne jamais obstruer l'entrée des ventilateurs d'évaporateur.
- Les produits plus difficiles à refroidir en raison de leur composition ou de leur taille doivent être placés au centre de l'appareil.
- Les informations de réfrigération rapide sont fournies pour des produits standard (à faible teneur en graisses) d'une épaisseur inférieure à 50 mm. Il faut donc éviter de superposer les produits sur les plateaux ou d'y placer des morceaux beaucoup plus épais, car cela prolongera le temps de réfrigération. Répartissez toujours bien le produit sur les plateaux et, dans le cas des morceaux épais, réduisez la quantité à réfrigérer rapidement.
- Limiter au minimum le nombre de fois et la durée d'ouverture des portes.
- Le réfrigérateur ne doit être utilisé que pour de courtes périodes de conservation des aliments.
- Lors du retrait des produits après une réfrigération ou congélation ultra rapide, toujours porter des gants de protection contre les brûlures par le gel.

Insérer la sonde alimentaire

- Avant de choisir le cycle à utiliser, la sonde doit être insérée dans l'aliment. Cela permet de mesurer la température à cœur de l'aliment.
- Il est important que la sonde soit correctement connectée à l'appareil sinon une alarme sera activée et l'appareil ne fonctionnera pas.

Remarque : Pour prévenir la contamination bactérienne ou la contamination de toute autre nature biologique, la sonde de pénétration doit être désinfectée après utilisation.

Interface utilisateur

Informations initiales

L'interface dispose des modes de fonctionnement suivants :

- **Off (Arrêt)** : l'appareil n'est pas alimenté
- **Stand-by (Veille)** : L'appareil est alimenté mais éteint
- **On (Allumé)** : L'appareil est sous tension, allumé et attend le démarrage d'un cycle de fonctionnement
- **Run (Marche)** : L'appareil est sous tension, allumé et en train d'exécuter un cycle de fonctionnement

Premier démarrage

Branchez l'appareil sur le réseau électrique. L'appareil affiche l'écran de chargement. Une fois le chargement terminé, l'écran affiche :

- l'écran d'accueil si vous appuyez sur la zone centrale de l'écran Marche/Veille
- l'écran d'accueil directement

Écran de marche/veille

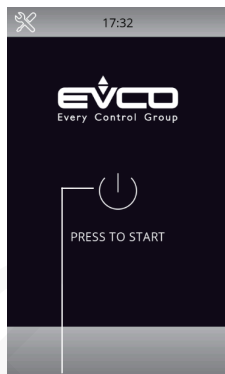

Appuyez sur cette zone centrale pour allumer

Écran d'accueil

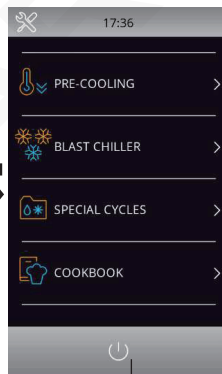

Appuyez sur cette zone inférieure pour éteindre l'écran

Remarques :

- "Allumer l'appareil" signifie passer du mode «Veille» au mode «Marche» ;
- «Éteindre l'appareil» signifie passer du mode «Marche» au mode «Veille».
- Si l'alimentation électrique fait défaut pendant le mode «Veille» ou «Marche», lorsque l'alimentation est rétablie, l'appareil revient au mode défini avant la panne.

Remarque : Si l'alimentation électrique a été coupée suffisamment longtemps pour provoquer une erreur d'horloge (code RTC), il sera nécessaire de réinitialiser la date et l'heure. La date et l'heure peuvent être réglées à partir de l'écran des paramètres (pour plus de détails, veuillez consulter la «Section 12.1» du manuel du contrôleur fourni avec l'appareil).

Sélection de la langue de l'écran

1. Dans l'écran d'accueil, appuyez sur la touche de réglage en haut à gauche. (🔧)
2. L'écran affiche le menu de réglage comme ci-dessous :

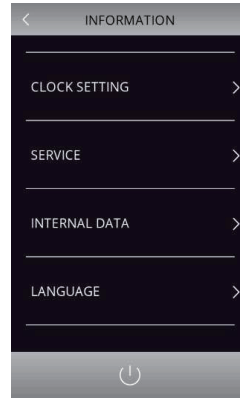

3. Appuyez sur «LANGUE» pour afficher le menu de langue.
4. Appuyez sur la langue souhaitée pour confirmer (Remarque : la langue par défaut est l'anglais).

Déverrouillage du clavier

Si le clavier est verrouillé, un menu s'affiche lorsqu'on le touche. Faites glisser le doigt vers la droite pour le déverrouiller.

Mettre l'appareil sur silence

Appuyez sur n'importe quelle touche pendant que la sonnerie retentit pour l'arrêter.

Signal d'ouverture de la porte

Lorsque la porte est ouverte, le signal apparaît

 sur l'écran. Appuyez sur n'importe quelle zone de l'écran pour supprimer ce signal.

Sélection du mode de fonctionnement

Les fonctions de fonctionnement sont accessibles depuis l'écran d'accueil en sélectionnant la zone souhaitée.

Remarque :

Pour l'utilisation de l'appareil, veuillez suivre les indications de l'écran pour les opérations instantanées. Vous pouvez également vous référer au manuel du contrôleur fourni avec l'appareil pour plus de détails.

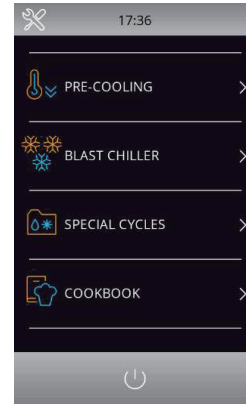

	<p>Appuyez sur cette zone pour sélectionner un cycle de pré-refroidissement de l'armoire. (Pour plus de détails, voir la section 10 du manuel du contrôleur fourni avec l'appareil).</p>
	<p>Mode de refroidissement par soufflage. Dans ce mode, vous pouvez sélectionner/régler un cycle standard de refroidissement/de congélation par soufflage, une sonde à aiguilles multiples ou un cycle à retardement multiple. (Pour plus de détails, voir la section 7 du manuel du contrôleur fourni avec l'appareil).</p>
	<div style="display: flex; align-items: center;"> <div style="margin-right: 10px;"> </div> <div style="margin-right: 10px;">→</div> <div style="margin-right: 10px;"> </div> <div style="margin-right: 10px;">→</div> <div style="margin-right: 10px;"> </div> <div style="margin-left: 10px;"> <p>Mode cycles spéciaux ; Dans ce mode, seule la fonction de chauffage de la sonde est prise en charge. (Pour plus de détails, voir les sections 6.2 et 8.6 du manuel du contrôleur fourni avec l'appareil).</p> </div> </div>
	<p>Permet d'accéder au mode livre de recettes, dans lequel des recettes préenregistrées peuvent être sélectionnées. (Pour plus de détails, voir la section 9 du manuel du contrôleur fourni avec l'appareil).</p>
	<p>Cette zone apparaît si une alarme est activée.</p>
	<p>Appuyez sur cette zone pour voir les données historiques enregistrées pendant le fonctionnement. (Pour plus de détails, voir les sections 7.6.2 et 12.2 du manuel du contrôleur fourni avec l'appareil).</p>

Nettoyage, entretien et maintenance



N'oubliez jamais d'éteindre et de débrancher l'appareil avant de procéder à son nettoyage.

- Nettoyez l'intérieur de l'appareil aussi souvent que possible.
- N'utilisez aucun produit de nettoyage abrasif. Ces produits peuvent laisser des résidus nocifs.
- Le joint de porte ne se nettoie qu'à l'eau.
- Veillez à le sécher en l'essuyant après nettoyage.
- Ne laissez pas l'eau de nettoyage s'écouler à travers l'orifice de vidange du bac d'évaporation.
- Soyez prudent quand vous nettoyez l'arrière de l'appareil. Les bords effilés peuvent couper.

De la condensation se formera dans la réfrigération avec une ouverture fréquente des portes et lors des journées chaudes et humides, veuillez vous assurer que la condensation s'évacue correctement ou qu'elle est essuyée.

Entretien de l'inox

Veillez lire les informations suivantes sur l'entretien de l'extérieur en inox de votre appareil Polar :

Ne jamais :

- Utiliser de tampons abrasifs, etc.
- Utiliser de détergents chlorés ou acides
- Laisser de saletés, de résidus alimentaires ou de produits chimiques de nettoyage sur la surface pendant de longues périodes. Les nettoyer immédiatement.
- Laisser la surface mouillée

À faire :

- Nettoyer souvent
- Utiliser des chiffons doux et des tampons en plastique
- Frotter dans le sens du grain du métal et non l'inverse
- Utiliser des détergents et produits d'entretien spécialement conçus pour l'inox
- Veiller à bien rincer les produits de nettoyage et à essuyer l'inox

Nettoyage de l'évaporateur

- Nettoyer régulièrement l'évaporateur.
 - Comme les ailettes de l'évaporateur sont très tranchantes, toujours porter des gants de protection.
 - Seule une brosse peut être utilisée pour le nettoyage. Ne pas utiliser de jets de liquides ou des instruments tranchants.
 - Pour accéder à l'évaporateur, procéder comme suit :
1. Ouvrir la porte (A) de l'appareil.
 2. Desserrer les deux vis (B) à droite du déflecteur.
 3. Enlever le coulisseau (C).
 4. Tourner le déflecteur (D) vers la gauche.

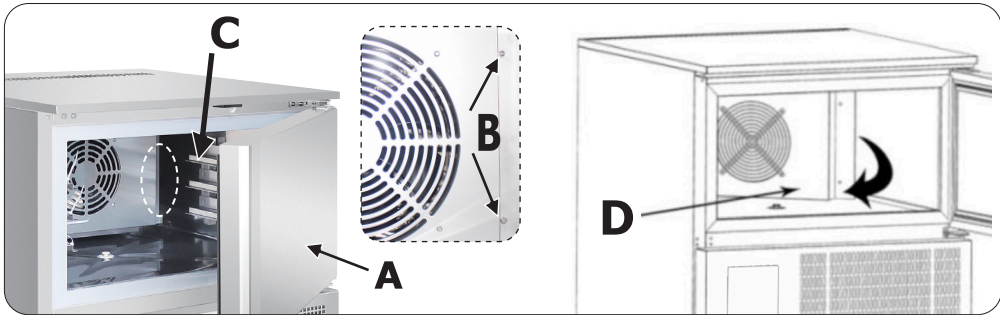

Nettoyage du condenseur

- Nettoyer régulièrement le condenseur.
 - Comme les ailettes du condenseur sont très tranchantes, toujours porter des gants de protection.
 - Utiliser des masques et des lunettes de protection en présence de poussière.
 - Chaque fois que le condenseur a un dépôt de poussière sur les ailettes, celui-ci peut être enlevé à l'aide d'un dispositif d'aspiration ou avec une brosse, en utilisant un mouvement vertical dans le sens des ailettes.
 - Aucun autre instrument ne doit être utilisé, ce qui pourrait déformer les ailettes et donc réduire l'efficacité de l'appareil.
 - Pour le nettoyage, procéder comme suit :
1. Ouvrir la porte (A) des appareils.
 2. Retirer le panneau inférieur (B). Pour ce faire, retirer les vis de fixation (C).
 3. Il est maintenant possible de nettoyer la partie à ailettes du condenseur (D) à l'aide des outils et dispositifs de protection appropriés.
 4. Après le nettoyage, fermer le panneau de commande et le fixer avec les vis retirées au préalable.

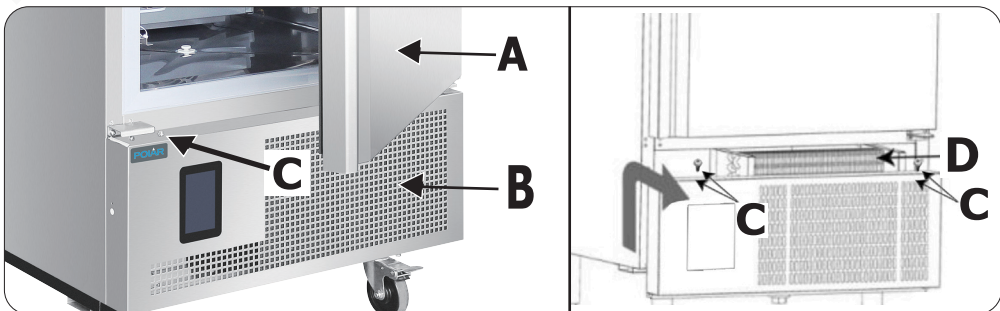

Dépannage

Un technicien qualifié doit effectuer les réparations si nécessaire.

Dysfonctionnement	Cause probable	Intervention
L'appareil ne fonctionne pas	L'appareil n'est pas allumé	Vérifier que l'appareil est bien branché et allumé
	La fiche ou le câble est endommagé	Remplacez la fiche ou le câble
	Défaut d'alimentation secteur	Vérifier l'alimentation secteur
L'appareil a une fuite d'eau	L'appareil n'est pas correctement nivelé	Visser les pieds réglables pour niveler l'appareil (le cas échéant)
	L'évacuation est	Nettoyer la trémie de sortie
	La circulation de l'eau vers l'évacuation est obstruée	Nettoyer le fond de l'appareil (le cas échéant)
	Le réservoir d'eau est endommagé	Consultez un technicien qualifié
L'appareil est trop bruyant	L'appareil n'a pas été installé de niveau ou dans une position stable	Vérifier la position de l'installation et la modifier si nécessaire
	Écrou/vis desserré(e)	Vérifier et serrer tous les écrous et vis
L'appareil ne refroidit pas	Programme incorrect	Changer de programme - voir le manuel du régulateur
	Le filtre est bouché	Nettoyer les filtres
La température des aliments n'est pas détectée	La sonde alimentaire est cassée	Commander une nouvelle sonde alimentaire auprès de votre distributeur
Les aliments ont des brûlures de congélation après avoir été retirés de l'appareil	Le cycle sélectionné n'est pas adapté aux aliments	Modifier le cycle de congélation intensive à congélation progressive (→ Sélection du mode de fonctionnement)
L'appareil émet un bip et un message apparaît sur le panneau de commande	Il y a un problème qui est indiqué par le signal d'alarme du panneau	Voir le tableau ci-dessous

Message/code du panneau de commande	Signification	Action requise
RTC	Erreur d'horloge	Réinitialiser la date et l'heure. Pour plus de détails, voir la section 12.1 : "Service" dans le manuel du contrôleur fourni avec l'appareil
SONDE D'ARMOIRE	Erreur de sonde d'armoire	<ul style="list-style-type: none"> Vérifier que la sonde n'est pas endommagée Vérifier la connexion appareil-sonde Vérifier la température de l'armoire Si le problème persiste, appeler l'agent POLAR ou un technicien qualifié
SONDE D'OPERATEUR	Erreur de la sonde de l'évaporateur	Même processus que pour l'erreur de la sonde de l'armoire mais en se référant à la sonde de l'évaporateur
SONDE DU CONDENSEUR	Erreur de la sonde du condenseur	Identique à l'erreur de la sonde de l'armoire, mais en se référant à la sonde du condenseur
SONDE DE L'AIGUILLE 1/2/3	Erreur de la sonde de l'aiguille/sonde 1/2/3	Identique à l'erreur de la sonde de l'armoire mais avec référence à la sonde de l'aiguille 1/2/3
SONDE DE L'AIGUILLE	Alarme de la sonde d'aiguille (tous les capteurs de la sonde d'aiguille activés sont en alarme état)	Identique à l'erreur de la sonde de l'armoire mais en référence à toutes les sondes à aiguille
INSERTION DE LA SOURCE D'AIGUILLE	Alarme de sonde d'aiguille non insérée	Vérifiez que les sondes d'aiguille ont été correctement insérées
PORTE OUVERTE	Alarme de porte ouverte	Vérifier l'état de la porte
HAUTE TEMPERATURE	Température maximale (Alarme HACCP)	<ul style="list-style-type: none"> Vérifiez la température de l'armoire
BASSE TEMPERATURE	Température minimale (Alarme HACCP)	<ul style="list-style-type: none"> Vérifiez la température de l'armoire
ALARME DE PANNE D'ALIMENTATION	Alarme de panne d'alimentation (alarme HACCP)	Vérifier la connexion entre l'appareil et l'alimentation

Remarque : Ce tableau liste uniquement les alarmes les plus courantes. Pour des informations plus détaillées sur les alarmes, veuillez consulter la "Section 16 Alarmes" du manuel du contrôleur

Spécifications techniques

Remarque : raison de notre processus d'amélioration continue, les spécifications des produits sont susceptibles d'être modifiées sans préavis.

Modèle	Tension	Puissance	Capacité	Poids (kg)	Température gamme	Réfrigérant	Dimensions H x W x D
UA014	230V~ 50Hz	700W	3 x GN1/1	104	+5°C ~ -35°C	R290	965 x 804 x 826
UA015		720W	5 x GN1/1	116	+5°C ~ -35°C	R290	1035 x 804 x 826
UA016		900W	10 x GN1/1	150	+5°C ~ -35°C	R290	1885 x 800 x 815

Modèle	Taux de réfrigération	Taux de congélation	Capacité de charge totale du refroidisseur	Capacité de charge totale du congélateur
UA014	90 min. (12kg)	240 min. (8kg)	12kg	8kg
UA015	90 min. (18kg)	240 min. (14kg)	18kg	14kg
UA016	90 min. (40kg)	240 min. (28kg)	40kg	28kg

Raccordement électrique

La prise doit être reliée à la prise secteur qui convient.

Cet appareil est câblé comme suit :

- Fil conducteur (brun) à la borne marquée L
- Fil neutre (bleu) à la borne marquée N
- Fil de terre (vert / jaune) à la borne marquée E

Cet appareil doit être mis à la terre.



En cas de doute, consultez un électricien qualifié.

Les points d'isolation électrique doivent être libres de toute obstruction. En cas de débranchement requis en urgence, ils doivent être facilement accessibles.

Mise au rebut

Les règlements de l'UE exigent que les produits munis de réfrigérants soient mis au rebut par des entreprises spécialisées, équipées pour extraire et recycler les composants à gaz, métalliques et en plastique.

Adressez-vous à votre autorité chargée de la collecte des déchets pour ce qui concerne la mise au rebut de votre appareil. Même si rien n'oblige les autorités locales à se charger de la mise au rebut du matériel de réfrigération commerciale, elles pourraient être en mesure de vous conseiller sur les moyens disponibles localement pour s'en débarrasser.

Vous pouvez aussi appeler le standard d'assistance POLAR, qui saura vous renseigner sur les entreprises de prise en charge nationales au sein de l'UE.

Conformité

Le logo WEEE qui figure sur ce produit ou sa documentation indique qu'il ne doit pas être mis au rebut avec les ordures ménagères. Pour éviter qu'il ne présente un risque pour la santé humaine et / ou écologique, confiez la mise au rebut de ce produit à un site de recyclage agréé respectueux de l'environnement. Pour de plus amples détails sur la mise au rebut appropriée de ce produit, contactez le fournisseur du produit ou l'autorité responsable de l'enlèvement des ordures dans votre région.



Les pièces POLAR ont été soumises à des tests rigoureux pour pouvoir être déclarées conformes aux normes et spécifications réglementaires définies par les autorités internationales, indépendantes et fédérales.



Les produits POLAR ont été déclarés aptes à porter le symbole suivant :

Tous droits réservés. La production ou transmission, partielles ou intégrales, sous quelque forme que ce soit ou par n'importe quel moyen, tant électronique que mécanique, sous forme de photocopie, d'enregistrement ou autre de ce mode d'emploi sont interdites sans l'autorisation préalablement accordée par POLAR.

Nous nous efforçons, par tous les moyens dont nous disposons, de faire en sorte que les détails contenus dans le présent mode d'emploi soient corrects en date d'impression. Toutefois, POLAR se réserve le droit de changer les spécifications de ses produits sans préavis.

Sicherheitshinweise

- Auf eine flache, stabile Fläche stellen.
- Alle erforderlichen Montage- und Reparaturarbeiten sollten von Wartungspersonal oder einem qualifizierten Techniker durchgeführt werden. Keine Bauteile oder Bedienflächen von diesem Produkt entfernen.
- Für folgende Normen und Vorschriften sind die lokalen und nationalen Normen heranzuziehen:
 - Arbeitsschutzvorschriften
 - BS EN Verhaltenspraktiken
 - Brandschutzvorschriften
 - IEE-Anschlussvorschriften
 - Bauvorschriften
- Das Gerät NICHT mit einem Strahl-/Hochdruckreiniger reinigen.
- Nur zum Gebrauch in Gebäuden.
- Das Gerät NICHT zum Aufbewahren von medizinischen Produkten verwenden.
- KEIN ÖL oder Fett mit den Kunststoffteilen oder der Türdichtung in Kontakt kommen lassen. Bei Kontakt sofort reinigen.
- Das Gerät stets aufrecht tragen, lagern und transportieren. Zum Transport den Schrank an der Unterseite anfassen.
- Vor Reinigungsarbeiten stets zunächst das Gerät abschalten und den Netzstecker ziehen.
- Verpackungsmaterial außerhalb der Reichweite von Kindern aufbewahren und gemäß den lokalen Vorschriften entsorgen.
- Aus Sicherheitsgründen muss ein beschädigtes Stromkabel von einem POLAR-Mitarbeiter oder empfohlenen qualifizierten Elektriker erneuert werden.

- Dieses Gerät sollte nur dann von Personen (einschließlich Kindern) mit reduzierten körperlichen, sensorischen oder geistigen Fähigkeiten, mangelnder Erfahrung oder Kenntnissen verwendet werden, wenn sie von einer für ihre Sicherheit verantwortlichen Person im Gebrauch des Geräts geschult wurden bzw. ständig beaufsichtigt werden.
- POLAR empfiehlt, dass dieses Gerät regelmäßig (wenigstens jährlich) von einem Fachmann überprüft wird. Die Überprüfung sollte beinhalten, ohne darauf beschränkt zu sein: Visuelle Überprüfung, Polaritätstest, Erdungskontinuität (Klasse-1-Geräte), Isolationskontinuität und Funktionalitätsprüfung.

Vorsicht: Brandgefahr



- Keine explosiven Stoffe wie Sprühdosen mit brennbarem Treibmittel in diesem Gerät nicht aufbewahren.



Warnung: Halten Sie alle Lüftungsöffnungen frei. Das Gerät sollte nicht ohne geeignete Ventilation eingebaut werden.

- **Warnung:** Verwenden Sie keine mechanischen Vorrichtungen oder andere Mittel, um den Abtauvorgang zu beschleunigen, außer denen, die vom Hersteller empfohlen wurden.
- **Warnung:** Beschädigen Sie den Kältemittelkreislauf nicht.
- **Warnung:** Verwenden Sie keine elektrischen Geräte innerhalb der Ablagefächer des Geräts.

Product Description

UA014 - POLAR-Schnellkühler Berührungsbildschirmsteuerung (3 x 1/1GN)

UA015 - POLAR-Schnellkühler Berührungsbildschirmsteuerung (5 x 1/1GN)

UA016 - POLAR-Schnellkühler Berührungsbildschirmsteuerung (10 x 1/1GN)

Einführung

Bitte nehmen Sie sich einige Minuten Zeit und lesen Sie dieses Handbuch sorgfältig durch. Nur bei korrekter Wartung und vorschriftsgemäßem Betrieb kann Ihr POLAR-Produkt optimale Leistung erzielen.

Lieferumfang

Folgende Teile befinden sich in der Verpackung:
POLAR-Tiefkühltsche

Bedienungsanleitung

POLAR ist stolz auf die hochwertige Qualität seiner Produkte und seinen erstklassigen Service. Wir stellen sicher, dass alle gelieferten Produkte zum Zeitpunkt der Verpackung voll funktionsfähig sind und sich in einwandfreiem Zustand befinden. Sollten Sie Transportschäden feststellen, wenden Sie sich bitte unverzüglich an Ihren POLAR-Händler.

Installation

Hinweis: Nicht zur Verwendung in Lieferwagen oder Anhängern, Transportern oder ähnlichen Fahrzeugen.

Wenn das Gerät nicht aufrecht transportiert oder gelagert wurde, muss es vor Inbetriebnahme rund 12 Stunden aufrecht aufgestellt werden. Im Zweifelsfall lassen Sie es aufrecht stehen.

1. Das Gerät aus der Verpackung nehmen. Darauf achten, dass die gesamte Plastikfolie und alle Beschichtungen von sämtlichen Flächen entfernt wurden.
2. Um die Leistung und Langlebigkeit zu optimieren, stellen Sie sicher, dass zwischen dem Gerät und den Wänden und anderen Objekten ein Mindestabstand von 2,5 cm eingehalten wird, wobei oben ein Mindestabstand von 20 cm eingehalten wird. **NIEMALS IN DER NÄHE EINER WÄRMEQUELLE.**

Hinweis: Reinigen Sie das Innere des Geräts vor der ersten Inbetriebnahme mit Seifenwasser und trocknen Sie es anschließend gut ab.

3. Die Bremsen an den Laufrollen feststellen, damit sich der Schrank nicht bewegen kann.

Umkehren der Tür

Je nach Standort des Geräts kann es sinnvoll sein, die Öffnungsrichtung der Tür zu ändern und die Seite des Türgriffs zu wechseln.

- Ziehen Sie den Netzstecker des Geräts.
- Tritt durch das Umkehren der Tür ein Produktproblem auf, ist die erforderliche Reparatur kostenpflichtig. Benötigen Sie dazu einen Techniker, kontaktieren Sie bitte einen Polar-Vertreter.
- Einzelheiten finden Sie in den Anweisungen auf den Seiten 62-65.

Betrieb

Lagerung von Nahrungsmitteln

Sie erzielen die besten Ergebnisse mit Ihrem POLAR-Gerät, wenn Sie folgende Anweisungen beachten:

- Die Temperatur der Nahrungsmittel, die in den Schockkühler/-froster gegeben werden, darf 90°C nicht übersteigen.
- Vorzugsweise sollten Metallbehälter/-schalen verwendet werden, da andere Materialien (wie Kunststoff- oder Styroporbehälter) isolierend wirken und die Kühlzeit verlängern.
- Die Produkte müssen ausreichend Abstand voneinander haben, damit ausreichend kalte Luft zwischen ihnen strömen kann. Darauf achten, dass das Produkt nicht die Innenwände des Geräts berührt, und ausreichend Platz zwischen den einzelnen Ablagen lassen.
- Nie den Eingang der Verdampferlüfter blockieren.
- Produkte, die aufgrund ihrer Inhaltsstoffe und Größe schwieriger zu kühlen sind, sollten in der Mitte des Geräts platziert werden.
- Die Schockfrostdaten beziehen sich auf Standardprodukte (mit niedrigem Fettgehalt), die weniger als 50 mm dick sind. Daher Produkte nicht auf den Schalen überlappen lassen und keine erheblich stärkeren Stücke einlegen, da sich die Schockfrostzeiten sonst erhöhen würden. Die Nahrungsmittel stets gleichmäßig auf den Ablagen verteilen. Bei dicken Stücken weniger Teile einlegen.
- Die Türen möglichst wenig und möglichst kurz öffnen.
- Der Schockfroster sollte nur für kurze Zeit zur Lagerung genutzt werden.
- Beim Entnehmen schockgefrosteter/-gekühlter Produkte stets Handschuhe tragen, um die Hände vor Kaltverbrennungen zu schützen.

Die Speisesonde einführen

- Vor der Auswahl des zu nutzenden Zyklus muss die Sonde in das Essen eingeführt werden. Dadurch kann die innere Temperatur des Essens gemessen werden.
- Es ist wichtig, dass die Sonde richtig mit dem Gerät verbunden ist. Ansonsten wird ein Alarm aktiviert und das Gerät funktioniert nicht.

Hinweis: Um eine bakterielle oder andere biologische Verunreinigung zu vermeiden, muss die Sonden-Nadel nach der Nutzung desinfiziert werden.

Benutzeranzeige

Anfängliche Informationen

Die Anzeige verfügt über die nachfolgenden Betriebsmodi:

- **Aus:** Keine Stromzufuhr zum Gerät
- **Bereitschaft:** Das Gerät wird mit Strom versorgt, ist jedoch ausgeschaltet
- **Ein:** Das Gerät wird mit Strom versorgt, ist eingeschaltet und wartet auf das Anlaufen eines Betriebszyklus
- **Betrieb:** Das Gerät wird mit Strom versorgt, ist eingeschaltet und führt einen Betriebszyklus aus.

Anfänglicher Betrieb

Schließen Sie das Gerät an die Netzversorgung an. Das Gerät zeigt den Ladebildschirm an. Nach dem Beenden des Ladens zeigt das Display:

- beim Drücken des zentralen Bereichs der Bereitschaftsanzeige die Startseite
- direkt die Startseite



Drücken Sie zum Einschalten auf diesen zentralen Bereich

Drücken Sie zum Ausschalten auf diesen unteren Bereich

Hinweis:

- „Gerät einschalten“ bedeutet vom Bereitschaftsmodus in den „EIN“-Zustand umzuschalten;
- „Gerät ausschalten“ bedeutet vom „EIN“-Zustand in den „Bereitschaftsmodus“ umzuschalten
- Sollte während des Bereitschaftszustands oder dem Betriebsmodus die Stromversorgung ausfallen, so kehrt das Gerät nach dem Wiederherstellen der Stromversorgung in den vor dem Stromausfall verwendeten Modus zurück.

Hinweis: Sollte die Stromversorgung lange genug ausfallen, um einen Uhrenfehler (RTC-Code) zu verursachen, so wird es notwendig sein, Datum und Uhrzeit zurückzustellen. Datum und Uhrzeit können vom Einstellbildschirm aus eingestellt werden (Für nähere Einzelheiten sehen Sie bitte „Abschnitt 12.1“ der mit dem Gerät mitgelieferten Bedienungsanleitung zur Steuerung).

Auswählen der Bildschirmsprache

1. Auf dem Startbildschirm drücken Sie bitte die Einstellungstaste  oben links.
2. Die Anzeige zeigt das Einstellmenü wie unten angegeben an:

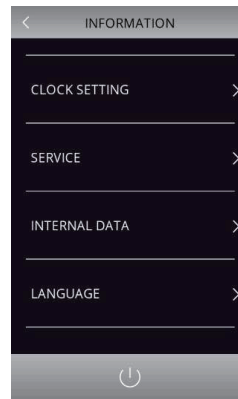

3. Drücken Sie auf "Sprache", um das Sprachmenü anzuzeigen.
4. Drücken Sie auf die gewünschte Sprache, um zu bestätigen (Bitte beachten: Die Standardsprache ist Englisch).

Tastenfeld entriegeln

Sollte das Tastenfeld verriegelt sein, erscheint bei Berührung ein Menü. Wischen Sie zum Entriegeln mit dem Finger nach rechts.

Summer ausschalten

Drücken Sie zum Abschalten während des Ertörens des Summers jegliche Taste.

Türöffnungssignal

Wenn die Tür geöffnet wird, erscheint auf dem

Display das Signal . Drücken Sie jeglichen

Bereich des Displays, um dieses Signal zu beenden.

Betriebsmodus auswählen

Die Betriebsfunktionen können von der Startseite durch Auswahl des gewünschten Bereichs ausgewählt werden.

Hinweis:

Für den sofortigen Betrieb befolgen Sie bitte während der Verwendung des Geräts die Bildschirmanweisungen. Sie können sich alternativ für nähere Einzelheiten in Bezug auf die Steuerung auch auf die Bedienungsanleitung des Herstellers beziehen.

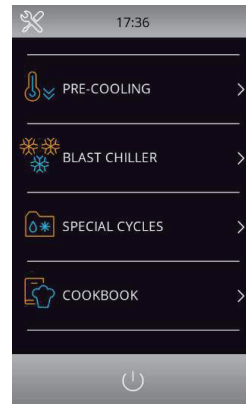

	<p>Drücken Sie auf diesen Bereich, um einen Vorkühlzyklus des Schrank auszuwählen. (Für nähere Einzelheiten sehen Sie bitte „Abschnitt 10“ der mit dem Gerät mitgelieferten Bedienungsanleitung zur Steuerung).</p>
	<p>Schnellkühlmodus. In diesem Modus können Sie einen Schnellkühlmodus/ Schnellgefriermodus, eine mehrnadhige Temperatursonde oder einen Zyklus mit mehreren Zeitschaltuhren auswählen. (Für nähere Einzelheiten sehen Sie bitte „Abschnitt 7“ der mit dem Gerät mitgelieferten Bedienungsanleitung zur Steuerung).</p>
	<p>Modus der speziellen Zyklen: In diesem Modus wird nur die Sondenheizfunktion unterstützt. (Für nähere Einzelheiten sehen Sie bitte „Abschnitt 6.2 und 8.6“ der mit dem Gerät mitgelieferten Bedienungsanleitung zur Steuerung).</p>
	<p>Ermöglicht den Zugang zum Rezeptbuchmodus, in dem vorgespeicherte Rezepte zur Auswahl verfügbar sind. (Für nähere Einzelheiten sehen Sie bitte „Abschnitt 9“ der mit dem Gerät mitgelieferten Bedienungsanleitung zur Steuerung).</p>
	<p>Der Bereich erscheint, wenn der Alarm deaktiviert wird.</p>
	<p>Drücken Sie auf diesen Bereich, um die während des Betriebs abgespeicherten Daten anzuzeigen. (Für nähere Einzelheiten sehen Sie bitte „Abschnitt 7.6.2 und 12.2“ der mit dem Gerät mitgelieferten Bedienungsanleitung zur Steuerung).</p>

Reinigung, Pflege und Wartung



Vor Reinigungsarbeiten stets zunächst das Gerät abschalten und den Netzstecker ziehen.

- Den Schrank möglichst häufig innen reinigen.
- Keine Scheuermittel verwenden, da diese schädliche Rückstände hinterlassen können.
- Die Türdichtung nur mit Wasser reinigen.
- Nach dem Reinigen stets mit einem Tuch trocknen.
- Zur Reinigung verwendetes Wasser darf nicht durch die Ablauföffnung in die Auffangschale gelangen.
- Vorsicht beim Reinigen der Geräterückseite. Scharfe Kanten können zu Verletzungen führen.

Bei häufigem Öffnen der Türen und an heißen, feuchten Tagen bildet sich in der Kühlung Kondenswasser, Bitte stellen Sie sicher, dass das Kondenswasser richtig ablaufen kann oder trocken gewischt wird.

Pflegeanleitung für Edelstahl

Damit Ihr Polar-Produkt sein einwandfreies Edelstahlaussehen behält, beachten Sie bitte Folgendes:

Niemals:

- Scheuernde Topfkratzer, Scheuerschwämme usw. verwenden
- Chlor- oder säurehaltige Reinigungsmittel verwenden
- Artikel wie Nahrungsmittel, Schmutz, Reinigungskemikalien usw. länger als nötig auf der Oberfläche lassen; diese Stoffe sofort entfernen.
- Die Oberfläche nass bleiben lassen.

Unbedingt:

- Oft reinigen.
- Weiche Tücher oder Kunststoffkratzer verwenden.
- Mit der Metallmaserung reiben, nicht dagegen.
- Reinigungsmittel und eine Politur zur Reinigung von Edelstahl verwenden.
- Darauf achten, dass die Reinigungsprodukte vollständig abgewaschen werden und der Stahl anschließend trocken ist.

Reinigen des Verdunsters

- Reinigen Sie den Verdunster regelmäßig.
- Da die Rippen des Verdunsters sehr scharf sind, tragen Sie immer Schutzhandschuhe.
- Zum Reinigen eignet sich nur eine Bürste. Verwenden Sie keinen Flüssigkeitsstrahl oder scharfe Utensilien.
- Um an den Verdunster zu gelangen, gehen Sie wie folgt vor:
 1. Öffnen Sie die Tür (A) des Geräts.
 2. Lockern Sie die beiden Schrauben (B) an der rechten Seite des Deflektors.
 3. Entfernen Sie die Schiene(C).
 4. Drehen Sie den Deflektor (D) nach links.

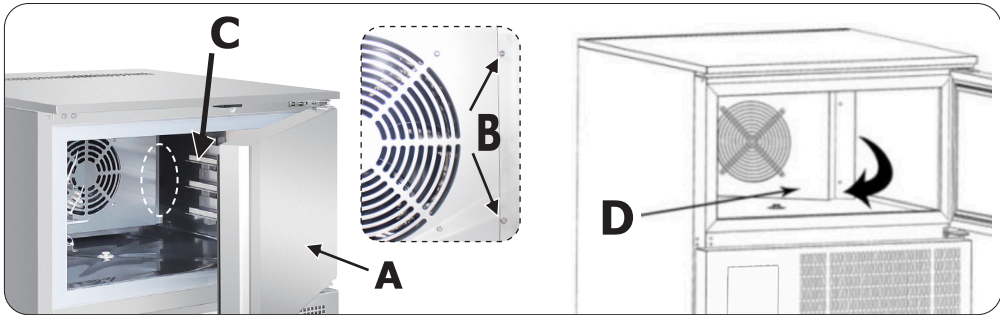

Reinigen des Kondensators

- Reinigen Sie den Kondensator regelmäßig.
- Da die Rippen des Kondensators sehr scharf sind, tragen Sie immer Schutzhandschuhe.
- Verwenden Sie bei Staub Schutzmasken und -brillen.
- Wenn der Kondensator über eine Staubansammlung an den Rippen verfügt, kann diese mit einer Absaugvorrichtung oder einer Bürste entfernt werden, indem sie vertikal entlang der Richtung der Rippen bewegt wird.
- Es dürfen keine anderen Utensilien verwendet werden, die Rippen deformieren können und somit die Effizienz des Gerätes beeinträchtigen.
- Gehen Sie zur Reinigung wie folgt vor:
 1. Öffnen Sie die Tür (A) des Geräts.
 2. Entfernen Sie das untere Panel (B). Lösen Sie dazu die Verschraubungen(C).
 3. Nun können Sie den Rippenteil des Kondensators (D) reinigen, indem Sie entsprechende Werkzeuge und Schutzvorrichtungen verwenden.
 4. Schließen Sie nach der Reinigung das Steuerpanel und befestigen Sie es mit den zuvor entfernten Schrauben.

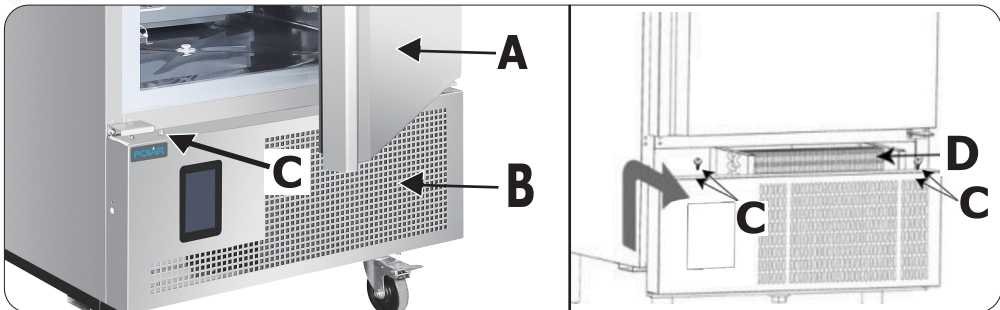

Störungssuche

Falls erforderlich, muss ein qualifizierter Techniker Reparaturen durchführen.

Störung	Vermutliche Ursache	Lösung
Das Gerät funktioniert nicht	Das Gerät ist nicht eingeschaltet	Prüfen, ob der Netzstecker in die Steckdose gesteckt wurde und das Gerät eingeschaltet ist
	Stecker und Kabel sind beschädigt	Stecker oder Leitung ersetzen
	Fehler Netzstromversorgung	Prüfe Netzstromversorgung
Aus dem Gerät leckt Wasser	Das Gerät ist nicht gerade aufgestellt	Passen Sie die Schraubfüße an, um das Gerät zu begradigen (→ wenn anwendbar).
	Der Abfluss ist verstopft	Säubern Sie die Abflussöffnung
	Das Wasser kann nicht zum Abfluss gelangen	Reinigen Sie den Boden des Gerätes (→ wenn anwendbar).
	Der Wasserbehälter ist beschädigt	Wenden Sie sich an einen qualifizierten Techniker
Das Gerät ist ungewöhnlich laut	Das Gerät wurde nicht in einer geraden oder stabilen Position installiert	Überprüfen Sie die Geräteposition und ändern Sie sie, wenn nötig
	Lockere Mutter/Schraube	Überprüfen Sie alle Muttern und Schrauben und ziehen Sie diese an
Das Gerätkühlt nicht	Falsches Programm	Ändern Sie das Programm – s. Steuerungsanleitung
	Der Filter ist verstopft	Reinigen Sie die Filter
Die Speisetemperatur wird nicht erkannt	Die Speisesonde ist defekt	Kaufen Sie eine neue Speisesonde bei Ihrem lokalen Vertrieb.
Das Essen hat nach dem Herausnehmen aus der Einheit Gefrierbrand	Der ausgewählte Zyklus ist nicht geeignet für das Essen	Ändern Sie den Zyklus von hartem Einfrieren zu sanftem Einfrieren (→ Einen Zyklus auswählen)
Das Gerät piept und eine Nachricht erscheint auf dem Steuerungsfeld	Es gibt ein Problem mit dem Gerät, das vom Kontroll-Alarmsignal angezeigt wird	Siehe Tabelle unten

Nachricht des Steuerungsfeldes message	Bedeutung	Erforderliche Handlung
RTC	Uhrenfehler	Stellen Sie Datum und Uhrzeit zurück. (Für nähere Einzelheiten sehen Sie bitte „Abschnitt 12.1“ der mit dem Gerät mitgelieferten Bedienungsanleitung zur Steuerung)
SCHRANKSONDE	Schranksondenfehler	<ul style="list-style-type: none"> Überprüfen Sie, ob die Sonde unbeschädigt ist Überprüfen Sie den Anschluss der Schranksonde Überprüfen Sie die Schranktemperatur Wenn das Problem anhält, kontaktieren Sie den POLAR-Agenten oder eine qualifizierte Fachkraft
VERDAMPFERSONDE	Verdampfersondenfehler	Genauso wie der Schranksondenfehler, jedoch in Bezug auf die Verdampfersonde
KONDENSATORSONDE	Kondensatorsondenfehler	Genauso wie der Schranksondenfehler, jedoch in Bezug auf die Kondensatorsonde
NADELSONDENSSENSOR 1/2/3	Nadelsonden-/sensorfehler 1/2/3	Genauso wie der Schranksondenfehler, jedoch in Bezug auf die Nadelsonde
NADELSONDE	Nadelsondenalarm (alle aktivierten Nadelsondensenoren sind im Alarmzustand)	Genauso wie der Schranksondenfehler, jedoch in Bezug auf alle Nadelsonden
NADELSONDENEINFÜHRUNG	Türöffnungsalarm	Überprüfen Sie, ob alle Nadelsonden korrekt eingeführt wurden
TÜR OFFEN	Türöffnungsalarm	Türzustand überprüfen
HOHE TEMPERATUR	Alarm der Maximaltemperatur (HACCP-Alarm)	<ul style="list-style-type: none"> Überprüfen Sie die Schranktemperatur
NIEDRIGE TEMPERATUR	Alarm der Minimaltemperatur (HACCP-Alarm)	<ul style="list-style-type: none"> Überprüfen Sie die Schranktemperatur
STROMVERSAGEN	Stromausfallalarm	Überprüfen Sie den Anschluss der Gerätestromversorgung

Bitte beachten: Diese Tabelle zeigt nur die grundlegenden Alarmzustände an. (Für nähere Einzelheiten sehen Sie bitte „Abschnitt 9“ der Bedienungsanleitung zur Steuerung).

Technische Daten

Hinweis: Aufgrund unseres kontinuierlichen Forschungs- und Entwicklungsprogramms können sich die hier aufgeführten Spezifikationen ohne vorherige Ankündigung ändern.

Modell	Spannung	Leistung	Kapazität	Gewicht (kg)	Temperaturbereich	Kühlmittel	Abmessungen h x b x t mm
UA014	230V~ 50Hz	700W	3 x GN1/1	104	+5°C ~ -35°C	R290	965 x 804 x 826
UA015		720W	5 x GN1/1	116	+5°C ~ -35°C	R290	1035 x 804 x 826
UA016		900W	10 x GN1/1	150	+5°C ~ -35°C	R290	1885 x 800 x 815

Modell	Kühlтарif	Gefrierleistung	Kühler-Vollastkapazität	Gefrierschrank-Vollastkapazität
UA014	90 Min. (12kg)	240 Min. (8kg)	12kg	8kg
UA015	90 Min. (18kg)	240 Min. (14kg)	18kg	14kg
UA016	90 Min. (40kg)	240 Min. (28kg)	40kg	28kg

Elektroanschlüsse

Der Stecker muss in eine geeignete Steckdose gesteckt werden.

Das Gerät ist wie folgt verdrahtet:

- Stromführender Leiter (braun) an Klemme L
- Neutralleiter (blau) an Klemme N
- Erdleiter (grün/gelb) an Klemme E



Dieses Gerät muss geerdet sein.

Bei Fragen wenden Sie sich bitte an einen qualifizierten Elektriker.

Elektroisolierpunkte dürfen nicht blockiert werden. Bei einem Not-Stopp müssen diese Punkte jederzeit sofort zugänglich sein.

Entsorgung

Gemäß EU-Vorschriften müssen Kühlprodukte von Fachunternehmen entsorgt werden, die alle Gase, Metall- und Kunststoffbauteile entfernen oder recyceln.

Ihre Kommunalverwaltung kann Sie über die Entsorgung Ihres Geräts informieren. Kommunalbehörden sind nicht verpflichtet, gewerbliche Kühlgeräte zu entsorgen. Sie können Sie jedoch über lokale Annahmestellen informieren, die diese Geräte entsorgen.

Oder rufen Sie die POLAR-Helpline an. Wir verfügen über eine Liste nationaler Entsorger in den EU Staaten.

Konformität

Das WEEE-Logo an diesem Produkt oder in der Dokumentation weist darauf hin, dass das Produkt nicht mit dem normalen Hausmüll entsorgt werden darf. Um potenziellen Gesundheits- bzw. Umweltschäden vorzubeugen, muss das Produkt durch einen zugelassenen und umweltverträglichen Recyclingprozess entsorgt werden. Ausführliche Informationen zur korrekten Entsorgung dieses Produkts erhalten Sie von Ihrem Produktlieferanten oder der für die Müllentsorgung in Ihrer Region zuständige Behörde.



Alle POLAR-Produkte werden strengen Tests unterzogen, um die Einhaltung von Normen und Spezifikationen internationaler und nationaler Behörden und unabhängiger Organisationen zu gewährleisten.

POLAR-Produkte dürfen durch folgendes Symbol gekennzeichnet werden:



Alle Rechte vorbehalten. Diese Anleitung darf ohne vorherige schriftliche Genehmigung von POLAR weder ganz noch teilweise in irgendeiner Form oder auf irgendeinem Wege - einschließlich elektronischer, mechanischer Verfahren, durch Fotokopieren, Aufnahme oder andere Verfahren - vervielfältigt oder übertragen werden.

Es werden alle Anstrengungen unternommen um sicherzustellen, dass alle Angaben bei der Drucklegung korrekt sind. POLAR behält sich jedoch das Recht vor, Spezifikationen ohne Vorankündigung zu ändern.

Suggerimenti per la sicurezza

- Posizionare su una superficie piana e stabile.
- L'installazione e le eventuali riparazioni devono venire eseguite da un agente/tecnico qualificato. Non rimuovere i componenti o i pannelli di accesso dell'apparecchio.
- Verificare la conformità alle normative locali e nazionali di quanto segue:
 - Normativa antinfortunistica sul lavoro
 - Linee guida BS EN
 - Precauzioni antincendio
 - Normativa IEE sui circuiti elettrici
 - Norme di installazione
- NON utilizzare sistemi di lavaggio a getto o pressione per pulire l'apparecchio.
- Per esclusivo uso in ambienti chiusi.
- NON utilizzare l'apparecchio per conservare presidi medico-sanitari.
- NON mettere a contatto olio o grassi con i componenti in plastica o con la guarnizione dei portelli. Pulire immediatamente in caso di contatto.
- Trasportare, immagazzinare e movimentare l'apparecchio sempre in posizione verticale e spostarlo mantenendone la base.
- Spegner e disconnettere l'alimentazione dell'unità prima di pulirla.
- Tenere lontano l'imballaggio dalla portata dei bambini. Smaltire l'imballaggio in conformità alle normative locali.
- Se danneggiato, il cavo di alimentazione deve venire sostituito da un agente POLAR o da un tecnico qualificato al fine di prevenire eventuali rischi.

- L'apparecchio non è destinato a essere utilizzato da persone (inclusi i bambini) con ridotte capacità fisiche, sensoriali o mentali, o prive della necessaria esperienza e conoscenza dell'apparecchio, che non abbiano ricevuto supervisione o istruzioni relative all'utilizzo dell'apparecchio dalle persone responsabili della loro sicurezza.
- Polar raccomanda che questo apparecchio venga periodicamente testato (almeno una volta all'anno) da una persona competente. I test dovrebbero includere, ma non solo: ispezione visiva, test di polarità, continuità di terra, continuità di isolamento e test funzionale.

Attenzione: Rischio di incendio



- Non conservare sostanze esplosive, come bombolette spray con propellente infiammabile in questo apparecchio.

Attenzione: Tenere libere tutte le aperture di ventilazione. L'unità non deve essere installata senza una ventilazione adeguata.

- **Attenzione:** non utilizzare dispositivi meccanici o altri mezzi per accelerare il processo di sbrinamento, diversa dal fabbricante raccomandato Quelli da.
- **Attenzione:** Non danneggiare il circuito refrigerante.
- **Attenzione:** Non usare apparecchi elettrici all'interno degli scomparti per la conservazione degli alimenti.

Descrizione dei prodotti

UA014 - Congelatore POLAR rapido con controller touch screen (3 x 1/1GN)

UA015 - Congelatore POLAR rapido con controller touch screen (5 x 1/1GN)

UA016 - Congelatore POLAR rapido con controller touch screen (10 x 1/1GN)

Introduzione

Leggere con attenzione il presente manuale. La manutenzione e l'utilizzo corretti di questo apparecchio consentiranno di ottenere le massime prestazioni da questo prodotto POLAR.

Contenuto dell'imballaggio

L'imballaggio contiene quanto segue:
Congelatore POLAR

Manuale di istruzioni

POLAR garantisce una qualità e un servizio impeccabili e assicura che al momento dell'imballaggio tutti i componenti forniti sono integralmente funzionanti e privi di difetti. Nel caso siano rilevati danni risultanti dal trasporto del prodotto, rivolgersi immediatamente al rivenditore POLAR locale.

Installazione

Nota: Non per l'uso in furgoni o rimorchi, camion per il trasporto del cibo o veicoli simili.

Se l'apparecchio è stato immagazzinato o spostato in posizione non verticale, lasciarlo in posizione verticale per circa 12 ore prima di metterlo in funzione. In caso di dubbio, osservare comunque questa precauzione.

1. Rimuovere l'apparecchio dall'imballaggio. Assicurarsi che la pellicola protettiva e rivestimenti in plastica siano interamente rimossi da tutte le superfici.
2. Per ottimizzare le prestazioni e la longevità, assicurarsi che sia mantenuta una distanza minima di 2,5 cm tra l'unità e le pareti e altri oggetti, con una distanza minima di 20 cm nella parte superiore. **NON POSIZIONARE MAI VICINO A UNA FONTE DI CALORE.**

Nota: prima di utilizzare l'apparecchio per la prima volta, pulire l'interno con acqua saponata e asciugare bene.

3. Innestare i freni delle ruote a sfera per mantenere l'apparecchio in posizione.

Inversione della porta

A seconda del luogo in cui viene posizionato l'apparecchio, potrebbe essere necessario cambiare la direzione di apertura della porta, cambiando quindi anche il lato della maniglia della porta.

- Scollegare l'apparecchio dalla rete elettrica.
- Qualora si verificasse un problema con il prodotto a seguito dell'inversione della porta, qualsiasi azione di riparazione richiesta successivamente è a pagamento. Se si necessita di un tecnico, contattare un agente Polar.
- Per i dettagli, fare riferimento alle istruzioni, alle Pagine 62-65.

Funzionamento

Conservazione dei cibi

Per ottenere i migliori risultati dall'apparecchio POLAR, osservare le seguenti istruzioni:

- È importante che la temperatura degli alimenti inseriti nell'abbattitore di temperatura/ congelatore non superi i 90°C.
- Si consiglia di utilizzare contenitori o vassoi in metallo dal momento che altri materiali come la plastica o il polistirene agiscono da isolanti prolungando il tempo di abbattimento della temperatura.
- Al fine di garantire un flusso adeguato di aria fredda è indispensabile lasciare spazio sufficiente tra i prodotti. Assicurarsi che i prodotti non siano a contatto con le pareti interne dell'unità e lasciare spazi sufficienti tra i vassoi.
- Non ostruire l'ingresso delle ventole dell'evaporatore.
- I prodotti più difficili da refrigerare per composizione e dimensioni devono essere posizionati al centro dell'unità.
- I dati di abbattimento della temperatura si riferiscono a prodotti standard (a basso contenuto di grassi) con uno spessore inferiore ai 50 mm: per questo motivo è necessario evitare di sovrapporre i prodotti sui vassoi o di inserire pezzi di spessore molto superiore a quello indicato, in quanto questo prolungherebbe i tempi di abbattimento della temperatura. Distribuire sempre bene il prodotto sui vassoi e, in caso di porzioni più spesse, diminuire la quantità di cui abbattere la temperatura.
- Limitare il numero di volte e la durata del tempo di apertura degli sportelli.
- L'unità deve essere utilizzata per la conservazione solo per brevi periodi.
- Quando si estrae un prodotto che è stato sottoposto ad abbattimento di temperatura / congelamento, indossare sempre i guanti per proteggere le mani da ustioni da congelamento.

Inserire la sonda

- Prima di selezionare che ciclo usare, si deve inserire la sonda nel cibo. Questo permette di misurare la temperatura interna del cibo.
- È importante che la sonda sia correttamente collegata all'unità, o si attiva un allarme e lo strumento non funziona.

Nota: Per prevenire contaminazione batterica o di qualsiasi altra natura biologica, la sonda ad ago deve essere disinfettata dopo l'uso.

Interfaccia utente

Informazioni iniziali

L'interfaccia è dotata delle seguenti modalità operative:

- **Off:** Dispositivo non alimentato
- **Stand-by:** Il dispositivo è alimentato ma spento
- **On:** Il dispositivo è alimentato, acceso e in attesa di avvio di un ciclo operativo
- **Run:** Il dispositivo è alimentato, acceso e sta eseguendo un ciclo operativo

Accensione iniziale

Collegare l'apparecchio all'alimentazione di corrente elettrica.

L'apparecchio visualizzerà lo schermo di caricamento. Quando il caricamento sarà completo, lo schermo visualizzerà:

- La schermata home se si preme sull'area centrale nella schermata On/Stand-by
- La schermata home direttamente

Schermata On/Standby

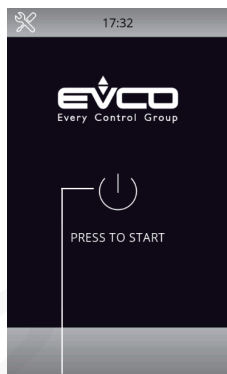

Premere in questa area in centro per accendere

Schermata Home

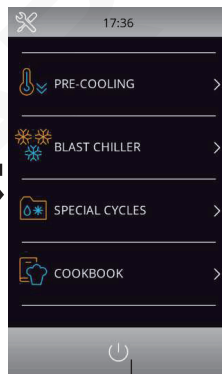

Premere in questa area in basso per spegnere

Nota:

- "Accendere il dispositivo" significa passare dalla modalità "stand-by" alla modalità "On";
- "Spegnere il dispositivo" significa passare dalla modalità "On" alla modalità "Stand-by".
- Se venisse a mancare la corrente durante le modalità "stand-by" o "on", quando ritornerà l'alimentazione il dispositivo tornerà alla modalità impostata prima dell'interruzione.

Nota: Se l'interruzione di corrente è stata così lunga da causare un errore di orologio (codice RTC) sarà necessario impostare nuovamente data e ora. (Per i dettagli si veda la "Sezione 12.1" nel manuale di controllo fornito con l'apparecchio)

Selezionare la lingua dello schermo

1. Sulla schermata Home, premere il tasto impostazioni  in alto a sinistra.
2. Lo schermo mostrerà il menù delle impostazioni come di seguito:

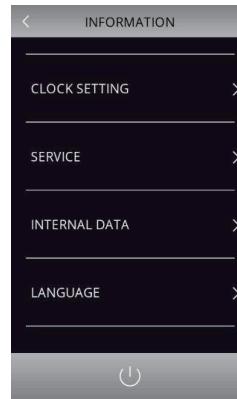

3. Premere "LINGUA" per visualizzare il menù delle lingue.
4. Premere sulla lingua desiderata per conferma (Nota: la lingua di default è l'inglese).

Sbloccare la tastiera

Se la tastiera è bloccata, quando la si tocca apparirà un menù. Scorrere con il dito verso destra per sbloccarla.

Silenziare la sirena

Premere qualunque tasto mentre la sirena sta suonando per interromperla.

Segnale di apertura porta

Quando la porta è aperta, apparirà il segnale  sullo schermo. Premere in una qualunque area dello schermo per rimuovere il segnale.





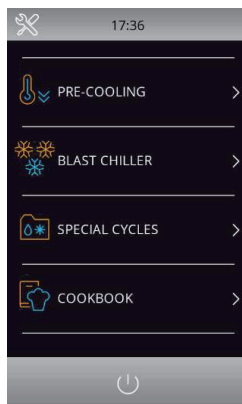

Selezionare la modalità operativa

È possibile accedere alle funzioni operative dalla schermata Home selezionando l'area desiderata.

Nota:

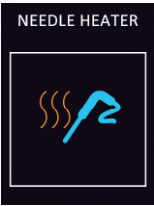
Per utilizzare l'apparecchio seguire le indicazioni sullo schermo per operazioni istantanee. Oppure è possibile fare riferimento al manuale di controllo fornito con l'apparecchio per ulteriori dettagli.



 PRE-COOLING >	<p>Premere in quest'area per selezionare un ciclo di pre-raffreddamento del mobile. (Per i dettagli si veda la Sezione 10 del manuale di controllo fornito con l'apparecchio)</p>
 BLAST CHILLER >	<p>Modalità di abbattimento rapido. In questa modalità è possibile selezionare/impostare un ciclo di abbattimento/congelamento rapido, una sonda multi-ago oppure un ciclo multi-timer. (Per i dettagli si veda la Sezione 7 del manuale di controllo fornito con l'apparecchio)</p>
 SPECIAL CYCLES >	<div style="display: flex; align-items: center;"> <div style="margin-right: 20px;">  </div> <div style="margin-right: 20px;">  </div> </div> <p>Modalità cicli speciali: In questa modalità è supportata solo la funzione di riscaldamento della sonda. (Per i dettagli si veda la Sezione 6.2 e 8.6 del manuale di controllo fornito con l'apparecchio).</p>
 COOKBOOK >	<p>Rende possibile accedere alla modalità ricettario, dove sono disponibili e si possono selezionare ricette pre-salvate. (Per i dettagli si veda la sezione 9 del manuale di controllo fornito con l'apparecchio.)</p>
	<p>Quest'area apparirà se viene attivato un allarme.</p>
	<p>Premere in quest'area per visualizzare i dati storici salvati durante il funzionamento. (Per i dettagli si vedano le sezioni 7.6.2 e 12.2 del manuale di controllo fornito con l'apparecchio).</p>

Pulizia e manutenzione



Prima di eseguire la pulizia, spegnere e scollegare l'alimentazione.

- Pulire l'interno dell'apparecchio quanto più spesso possibile.
- Non utilizzare detergenti abrasivi in quanto possono lasciare residui nocivi.
- Pulire la guarnizione di tenuta dei portelli solo con acqua.
- Asciugare sempre dopo la pulizia.
- Non permettere che l'acqua utilizzata per la pulizia penetri attraverso il foro di scarico nella vasca di evaporazione.
- Prestare attenzione durante la pulizia della parte posteriore dell'apparecchio. Gli attrezzi con bordi taglienti possono provocare tagli.

La condensa si formerà in refrigerazione con l'apertura frequente delle porte e nei giorni caldi e umidi, assicurarsi che la condensa possa defluire correttamente o che venga asciugata con un panno.

Istruzioni per la cura dell'acciaio inox

Per conservare l'aspetto esterno in acciaio inox del prodotto Polar, osservare le seguenti indicazioni:

- Non usare mai pagliette di metallo o pagliette abrasive.
 - Non usare mai detergenti acidi o clorurati.
 - Non lasciare cibi, sporcizia o detergenti chimici sulla superficie più a lungo del necessario: rimuoverli immediatamente.
 - Non lasciare la superficie bagnata o umida.
-
- Pulire frequentemente.
 - Utilizzare panni morbidi o pagliette in plastica.
 - Strofinare nel verso della satinatura e non al contrario.
 - Utilizzare detergenti e lucidanti specifici per la pulizia dell'acciaio inox.
 - Assicurarsi di sciacquare completamente i detergenti e che l'acciaio sia lasciato asciutto

Pulire l'evaporatore

- Pulire periodicamente l'evaporatore.
 - Siccome le alette dell'evaporatore sono molto taglienti, sempre indossare guanti protettivi.
 - Si può usare solamente una spazzola per pulire. Non usare getti di liquidi o strumenti appuntiti.
 - Per accedere all'evaporatore procedere come segue:
1. Aprire la porta (A) dello strumento.
 2. Allentare le due viti (B) sulla destra del deflettore.
 3. Rimuovere la guida (C).
 4. Girare il deflettore (D) a sinistra.

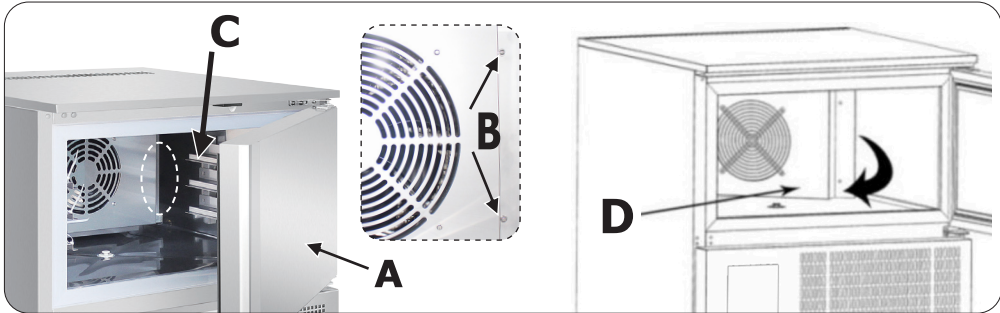

Pulire il condensatore

- Pulire periodicamente il condensatore.
 - Siccome le alette del condensatore sono molto taglienti, sempre indossare guanti protettivi.
 - Usare maschere e occhiali protettivi in presenza di polvere.
 - Ogni volta che il condensatore ha un deposito di polvere vicino alle alette, si può rimuovere usando un aspiratore o una spazzola pertinente, con un movimento verticale lungo la direzione delle alette.
 - Non si deve usare nessun altro strumento che possa deformare le alette e di conseguenza l'efficienza dello strumento.
 - Per pulire, procedere come segue:
1. Aprire la porta (A) dello strumento.
 2. Rimuovere il pannello inferiore (B). Per farlo, rimuovere i fissaggi a vite (C).
 3. Ora è possibile pulire la parte con le alette del condensatore (D) usando strumenti adatti e dispositivi protettivi.
 4. Dopo la pulizia, chiudere il pannello di controllo e fissarlo con le viti rimosse in precedenza.

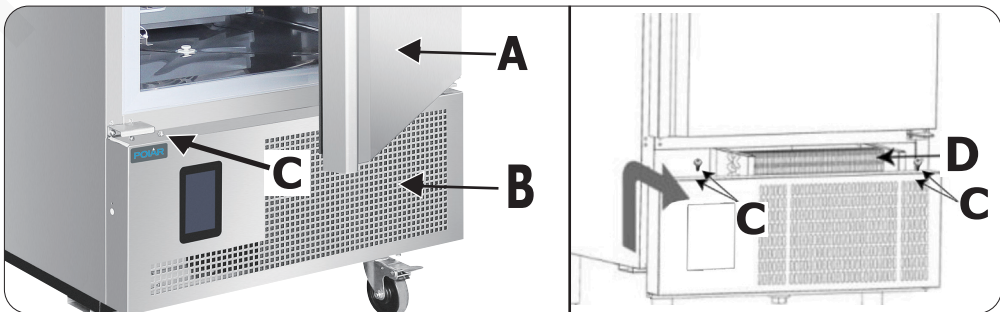

Risoluzione dei problemi

Se necessario, un tecnico qualificato deve eseguire le riparazioni.

Guasto	Probabile causa	Azione
L'apparecchio non funziona	L'apparecchio non è acceso	Controllare che l'apparecchio sia correttamente collegato e acceso
	La presa e il cavo sono danneggiati	Sostituire la spina o il cavo
	Guasto alimentazione di rete	Controllare l'alimentazione di rete
Lo strumento perde acqua	L'apparecchio non è ben allineato	Regolare i piedi a vite per allineare lo strumento (se applicabile)
	Lo scarico è ostruito	Liberare lo scarico
	Il movimento dell'acqua allo scarico è ostruito	Liberare il piano dello strumento (→ se applicabile)
	Il contenitore dell'acqua è danneggiato se l'acqua esce dal retro	Consultare un tecnico qualificato
Lo strumento è insolitamente rumoroso	L'apparecchio non è stato installato in una posizione piana o stabile	Controllare l'installazione e cambiarla se necessario
	Allentato Il dado/vite	Controllare e stringere tutti i dadi e le viti
Lo strumento non raffredda non viene rilevata	Programma errato	Cambiare programma - vedere manuale controller
	Il filtro è ostruito	Pulire i filtri
La temperatura del cibo	La sonda è rotta	Acquistare una sonda nuova dal Distributore
Il cibo ha bruciature da congelamento Dopo la rimozione Dall'unità	Il ciclo selezionato non è adatto per il cibo	Cambiare ciclo da congelamento forte a soave (→ Selezionare un ciclo)
Lo strumento emette Un segnale acustico e appare Un messaggio sul pannello di controllo	C'è un problema con l'unità indicato dal segnale d'allarme di controllo	Vedere tabella sotto

Messaggio Pannello di controllo	Significato	Azione richiesta
RTC	Errore orologio	Re-impostare data e ora. Per i dettagli si veda la "Sezione 12.1: Manutenzione" del manuale di controllo fornito con l'apparecchio
SONDA ARMADIO	Errore nella sonda armadio	<ul style="list-style-type: none"> • Verificare che la sonda non sia danneggiata • Controllare il collegamento dispositivo-sonda • Controllare la temperatura dell'armadio • Se il problema persiste contattare un agente POLAR o un tecnico qualificato
SONDA EVAPORATORE	Errore sonda evaporatore	Come per la sonda armadio ma con riferimento alla sonda evaporatore
SONDA CONDENSATORE	Errore sonda condensatore	Come per la sonda armadio ma con riferimento alla sonda condensatore
SONDA AD AGO SENSORE 1/2/3	Errore sonda ad ago/sensore 1/2/3	Come per la sonda armadio ma con riferimento alla sonda ad ago 1/2/3
SONDA AD AGO	Allarme sonda ad ago (tutti i sensori della sonda ad ago abilitati sono in stato di allarme)	Come per la sonda armadio ma con riferimento a tutte le sonde ad ago
INSERIMENTO SONDA AD AGO	Allarme di sonda ad ago non inserita	Controllare che le sonde ad ago siano state inserite correttamente
PORTA APERTA	Allarme porta aperta	Controllare lo stato della porta
TEMPERATURA ELEVATA	Allarme di temperatura massima (allarme HACCP)	<ul style="list-style-type: none"> • Controllare la temperatura nell'armadio
TEMPERATURA BASSA	Allarme di temperatura minima (allarme HACCP)	<ul style="list-style-type: none"> • Controllare la temperatura nell'armadio
INTERRUZIONE ALIMENTAZIONE	Allarme di interruzione alimentazione (allarme HACCP)	Controllare il collegamento del dispositivo alla presa di corrente
Nota: Questa tabella elenca solo gli allarmi basilari. Per informazioni più dettagliate sugli allarmi si veda la "Sezione 16 Allarmi" del manuale di controllo		

Specifiche tecniche

Nota: a causa del nostro continuo processo di miglioramento, le specifiche del prodotto sono soggette a modifiche senza preavviso.

Modello	Tensione	Alimentazio	Capacità	Peso (kg)	Intervallo di temperatura	Refrigerante	Dimensioni h x l x p mm
UA014	230V~ 50Hz	700W	3 x GN1/1	104	+5°C ~ -35°C	R290	965 x 804 x 826
UA015		720W	5 x GN1/1	116	+5°C ~ -35°C	R290	1035 x 804 x 826
UA016		900W	10 x GN1/1	150	+5°C ~ -35°C	R290	1885 x 800 x 815

Modello	Tasso di refrigerazione	Tasso di congelamento	Capacità a pieno carico del refrigeratore	Capacità a pieno carico del congelatore
UA014	90 min. (12kg)	240 min. (8kg)	12kg	8kg
UA015	90 min. (18kg)	240 min. (14kg)	18kg	14kg
UA016	90 min (40kg)	240 min (28kg)	40kg	28kg

Cablaggi elettrici

La spina deve venire collegata a una presa di rete appropriata.

L'apparecchio ha i seguenti cablaggi:

- Filo sotto tensione (colore marrone) a terminale L
- Filo del neutro (colore blu) a terminale N
- Filo di terra (colore verde/giallo) a terminale E

Questa apparecchiatura deve essere collegata a terra.



In caso di dubbi, consultare un elettricista qualificato.

I punti di isolamento elettrico devono essere liberi da ostruzioni. In caso di emergenza, i punti devono essere facilmente raggiungibili qualora sia necessario scollegarli.

Smaltimento

Le normative UE prevedono che lo smaltimento dei prodotti di refrigerazione sia eseguito da aziende specializzate nella rimozione o nel riciclaggio di tutti i gas e dei componenti in metallo e plastica.

Rivolgersi all'ente locale incaricato per informazioni sullo smaltimento di questo apparecchio. Gli enti locali non hanno l'obbligo di procedere allo smaltimento di apparecchi di refrigerazione commerciali ma sono in grado di fornire suggerimenti sulla modalità di smaltimento di tali apparecchi.

In alternativa, chiamare la helpline telefonica di POLAR per ricevere informazioni dettagliate sulle aziende di smaltimento nella UE.

Conformità

Il logo WEEE riportato su questo prodotto o sulla relativa documentazione indica che il prodotto non può essere smaltito come normale rifiuto domestico. Per evitare possibili danni alla salute e/o all'ambiente, il prodotto deve venire smaltito utilizzando una procedura di riciclaggio approvata e sicura per l'ambiente. Per ulteriori informazioni su come smaltire in maniera corretta questo prodotto, contattare il fornitore del prodotto o l'ente locale responsabile per lo smaltimento dei rifiuti.



I componenti POLAR sono stati sottoposti a un rigoroso collaudo ai fini della conformità agli standard e alle specifiche normative previste dalle autorità internazionali, indipendenti e federali.



I prodotti POLAR sono autorizzati a esporre il seguente simbolo:

Tutti i diritti riservati. È vietata la riproduzione o la trasmissione in alcuna forma, elettronica, meccanica, mediante fotocopiatura o altro sistema di riproduzione, di qualsiasi parte delle presenti istruzioni senza la previa autorizzazione scritta di POLAR.

Le informazioni contenute sono corrette e accurate al momento della stampa, tuttavia POLAR si riserva il diritto di modificare le specifiche senza preavviso.

Consejos de Seguridad

- Colóquelo sobre una superficie plana y estable.
- Un agente del servicio técnico cualificado debería llevar a cabo la instalación y cualquier reparación que se precise. No retire ningún componente ni panel de servicio de este producto.
- Consulte las Normas Locales y Nacionales correspondientes a lo siguiente:
 - Legislación de Seguridad e Higiene en el Trabajo
 - Códigos de Práctica BS EN
 - Precauciones contra Incendios
 - Normativas de Cableado de la IEE
 - Normativas de Construcción
- No utilice dispositivos de lavado de chorro / presión para limpiar el aparato.
- Sólo adecuado para uso en interiores.
- NO utilice este aparato para almacenar existencias médicas.
- NO deje que el aceite o la grasa entren en contacto con los componentes de plástico o la junta de la puerta. Limpie el aparato inmediatamente si se produce contacto.
- Siempre debe transportar, almacenar y manipular el aparato verticalmente y moverlo cogiéndolo de la base.
- Desconecte la máquina y desenchúfela del suministro eléctrico de la unidad siempre antes de llevar a cabo la limpieza.
- Mantenga el embalaje lejos del alcance de los niños. Deshágase del embalaje de acuerdo con las normativas de las autoridades locales.
- Si el cable eléctrico está dañado, debe ser reemplazado por un agente de POLAR o un técnico cualificado recomendado para evitar cualquier riesgo.

- Este aparato no debe ser utilizado por personas (niños incluidos) que tengan limitadas sus capacidades físicas, sensoriales o mentales, o que no tengan experiencia y conocimientos, a menos que estén bajo la supervisión o hayan recibido instrucciones relativas al uso del aparato a cargo de una persona responsable de su seguridad.
- POLAR recomienda que este aparato debe ser periódicamente probado (al menos anualmente) por una Persona Competente. La prueba debe incluir, pero no debe estar limitado a: Inspección visual, Prueba de polaridad, Toma a tierra, continuidad de aislamiento y prueba Funcional.

Precaución Riesgo de Incendio



- No guarde sustancias explosivas, tales como latas de aerosol con un propulsor inflamable, en este aparato.



Advertencia: Mantenga los orificios de ventilación libres de obstrucciones. Asegúrese de que la unidad disponga de una ventilación adecuada.

- **Advertencia:** No utilice dispositivos mecánicos u otros medios para acelerar el proceso de descongelación, que no sean aquellos recomendados por el fabricante.
- **Advertencia:** No dañe el circuito refrigerante.
- **Advertencia:** No utilice aparatos eléctricos dentro de los compartimentos de almacenamiento de alimentos del aparato.

Descripción del Producto

UA014 - Congelador POLAR con Controlador de Pantalla Táctil (3 x 1/1GN)

UA015 - Congelador POLAR con Controlador de Pantalla Táctil (5 x 1/1GN)

UA016 - Congelador POLAR con Controlador de Pantalla Táctil (10 x 1/1GN)

Introducción

Tómese unos minutos para leer este manual. El correcto mantenimiento y manejo de esta máquina proporcionará el mejor funcionamiento posible de su producto POLAR.

Contenido del Conjunto

Se incluye lo siguiente:

- Congelador
- Manual de instrucciones

POLAR se enorgullece de su calidad y servicio y asegura que en el momento del embalaje, el contenido se suministró con plena funcionalidad y sin ningún defecto. Si encontrara algún daño resultante del transporte, póngase en contacto inmediatamente con su distribuidor POLAR.

Instalación

Nota: No debe utilizarse en furgonetas o remolques, camiones de alimentos o vehículos similares.

Si el aparato no se ha almacenado o transportado en posición vertical, déjelo en posición vertical durante aproximadamente 12 horas antes del funcionamiento. Si tiene alguna duda, deje el aparato en posición vertical.

1. Desembale el aparato. Asegúrese de que todos los revestimientos y las láminas de plástico de protección se hayan quitado totalmente de todas las superficies.
2. Para optimizar el rendimiento y la longevidad, asegúrese de que se mantenga un espacio libre mínimo de 2,5 cm entre la unidad y las paredes y otros objetos, con un espacio mínimo de 20 cm en la parte superior. **NUNCA UBICAR AL LADO DE UNA FUENTE DE CALOR.**

Nota: Antes de utilizar el aparato por primera vez, limpie el interior con agua jabonosa y luego séquelo bien.

3. Coloque los frenos en las ruedecillas para mantener el aparato en su posición.

Inversión de la puerta

Dependiendo de la ubicación del aparato, puede ser necesario cambiar la dirección de apertura de la puerta cambiando el lado de la manilla.

- Desenchufe el aparato.
- En caso de que se produzca un problema con el producto como resultado de la inversión de la puerta, cualquier acción de reparación requerida será de pago. Si necesita que un técnico lleve a cabo la tarea, llame a un agente de Polar.
- Para más detalles, consulte las instrucciones de las páginas 62-65.

Funcionamiento

Almacenamiento de comida

Para obtener los mejores resultados de su aparato POLAR, siga estas instrucciones:

- Es importante que la comida que se coloque en el Refrigerador /Congelador por aire forzado no supere la temperatura de 90°C.
- Se recomienda el uso de bandejas/recipientes de metal ya que cualquier otro material de los recipientes como plástico o poliestireno actuará como aislante y alargará los tiempos de refrigeración por aire forzado
- Debe dejarse espacio suficiente entre los productos para garantizar un flujo suficiente de aire frío. Procure que los productos no toquen las paredes internas de la unidad, y deje suficiente espacio entre las bandejas.
- No obstruir nunca la entrada de los ventiladores del evaporador.
- Los productos que son más difíciles de enfriar debido a su composición y tamaño deben colocarse en el centro de la unidad.
- Los datos del refrigerador por aire forzado se refieren a productos estándar (bajo contenido de grasa) con un grosor por debajo de 50 mm: por tanto, evite sobreponer productos en las bandejas o la colocación de piezas con más grosor, ya que esto conllevaría un alargamiento de los tiempos de refrigeración por aire forzado. Distribuya siempre bien el producto en las bandejas y en el caso de piezas gruesas disminuya la cantidad a enfriar en el refrigerador.
- Limite el número de veces y la duración en que se abren las puertas.
- El refrigerador solo debe utilizarse para guardar alimentos por periodos cortos de tiempo.
- Al retirar los productos que han sido sometidos a refrigeración /congelación rápida, lleve siempre guantes para proteger las manos de posibles quemaduras por frío.

Inserte la sonda de alimentos

- Antes de seleccionar qué ciclo utilizar, la sonda debe insertarse en los alimentos. Esto permite medir la temperatura interna del alimento.
- Es importante que la sonda esté conectada correctamente a la unidad, de lo contrario se activará una alarma y el aparato no funcionará.

Nota: Para evitar la contaminación bacteriana o la contaminación de cualquier otra naturaleza biológica, la aguja de la sonda debe ser desinfectada después de su uso.

Interfaz de usuario

Información inicial

La interfaz tiene los siguientes modos de funcionamiento:

- **Apagado:** El dispositivo no recibe alimentación.
- **Espera:** El dispositivo está alimentado pero apagado.
- **Encendido:** El dispositivo está alimentado, encendido y a la espera de iniciar un ciclo de funcionamiento.
- **Funcionando:** El dispositivo está alimentado, encendido y ejecutando un ciclo de funcionamiento

Encendido inicial

Conecte el aparato a la Red Eléctrica. El aparato mostrará la pantalla de carga. Una vez finalizada la carga, la pantalla mostrará:

- la pantalla de Inicio si se pulsa el área central en la pantalla de Encendido/Espera
- la pantalla de Inicio directamente

Pantalla de Encendido/
Espera



Pulse esta área central para Encender

Pantalla de Inicio

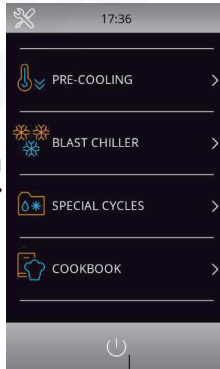

Pulse esta área inferior para Apagar

Nota:

- "Encender el aparato" significa pasar del Modo de "Espera" al modo "Encendido";
- "Apagar el aparato" significa pasar del Modo "Encendido" al modo de "Espera".
- Si el suministro de energía falla durante el Modo de "Espera" o "Encendido", cuando se restablezca la energía el dispositivo volverá al modo establecido antes del fallo.

Nota: Si la alimentación se ha cortado lo suficiente como para provocar un error de reloj (código RTC), será necesario restablecer la fecha y la hora. La fecha y la hora se pueden configurar desde la pantalla de configuración (Para obtener más detalles, consulte la "Sección 12.1" en el Manual del controlador suministrado con el aparato).

Selección del idioma de la pantalla

1. Estando en la pantalla de inicio, pulse la tecla  de la parte superior izquierda.
2. La pantalla mostrará el Menú de Ajustes como se indica a continuación:

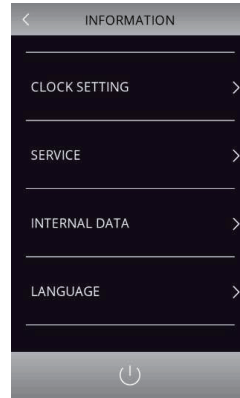

3. Pulse "IDIOMA" para mostrar el Menú de idiomas.
4. Pulse el idioma deseado para confirmar (Nota: El idioma predeterminado es el Inglés).

Desbloquear el teclado

Si el teclado está bloqueado, al tocarlo aparecerá un menú. Deslice el dedo hacia la derecha para desbloquearlo.

Silenciar el Zumbador

Pulse cualquier tecla mientras suena el zumbador para que deje de sonar.

Señal de puerta abierta

Quando se abre la puerta, la señal  aparecerá en la pantalla. Pulse cualquier área de la pantalla para eliminar esta señal.

Limpieza, cuidados y mantenimiento



Desconecte la máquina y desenchúfela de la toma eléctrica antes de llevar a cabo la limpieza.

- Limpie el interior del aparato con la mayor frecuencia posible.
- No utilice productos de limpieza abrasivos. Estos pueden dejar residuos nocivos.
- Limpie la junta de la puerta sólo con agua.
- Seque bien el aparato después de limpiarlo.
- No permita que el agua utilizada en la limpieza pase por el agujero de desagüe hacia el recipiente de evaporación.
- Vaya con cuidado al limpiar la parte trasera del aparato. Los bordes afilados pueden cortar.

Se formará condensación en refrigeración con apertura frecuente de las puertas y en días calurosos y húmedos, asegúrese de que el condensado pueda drenar correctamente o que se seque con un paño.

Cuidado del acero inoxidable

Para mantener el exterior del acero inoxidable de su unidad Polar, por favor, considere la siguiente información:

Nunca:

- Utilice estropajos o esponjas de fregar abrasivas, etc.
- Utilice detergentes clorados o ácidos
- Deje nada, por ejemplo, sustancias químicas de limpieza, suciedad o comida sobre la superficie durante más tiempo de lo necesario. Límpielos inmediatamente.
- Deje que la superficie permanezca húmeda.

Siempre:

- Limpie con frecuencia.
- Utilice paños suaves o estropajos plásticos.
- Frote con la textura granular del metal más que a través de la misma.
- Utilice detergentes y ceras diseñados para la limpieza de acero inoxidable.
- Asegúrese de que los productos de limpieza se quiten por completo lavando y que el acero quede seco.

Limpeza del evaporador

- Limpie periódicamente el evaporador.
- Use siempre guantes protectores ya que las láminas del evaporador están muy afiladas.
- Sólo debe utilizar un cepillo para la limpieza. No utilice chorros de líquidos ni instrumentos afilados.
- Para acceder al evaporador:
 1. Abra la puerta (A) del aparato
 2. Afloje los dos tornillos (B) a la derecha del deflector
 3. Retire la guía (C)
 4. Gire el deflector (D) hacia la izquierda.

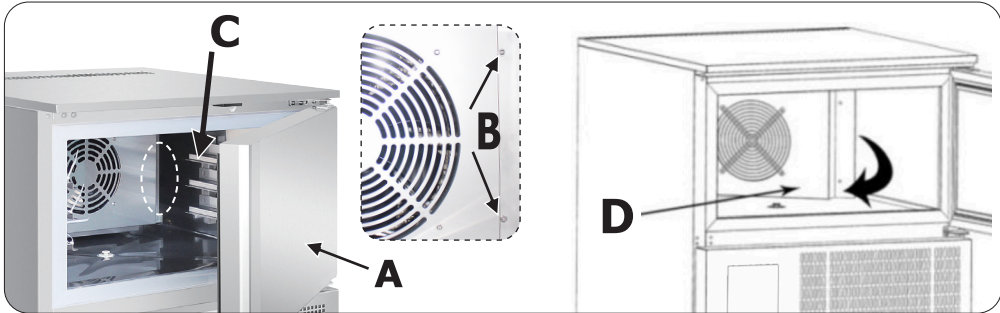

Limpeza del condensador

- Limpie el condensador periódicamente.
- Use siempre guantes protectores ya que las láminas del evaporador están muy afiladas.
- Use máscara protectora y gafas si hubiera polvo.
- Siempre que el condensador tenga un depósito de polvo bajo las aletas, éste se puede limpiar con un aspirador o con un cepillo, realizando un movimiento vertical en la dirección de las láminas.
- No se deben utilizar otros instrumentos que puedan deformar las láminas y, por tanto, la eficacia del aparato.
- Para limpiar, proceda de la siguiente manera:
 1. Abra la puerta (A) del aparato.
 2. Retire el panel inferior (B). Para ello, retire los tornillos (C).
 3. Ahora es posible limpiar la parte de las láminas del condensador (D) utilizando las herramientas y dispositivos de protección adecuados.
 4. Después de la limpieza, cierre el panel de control y fije los tornillos retirados antes.

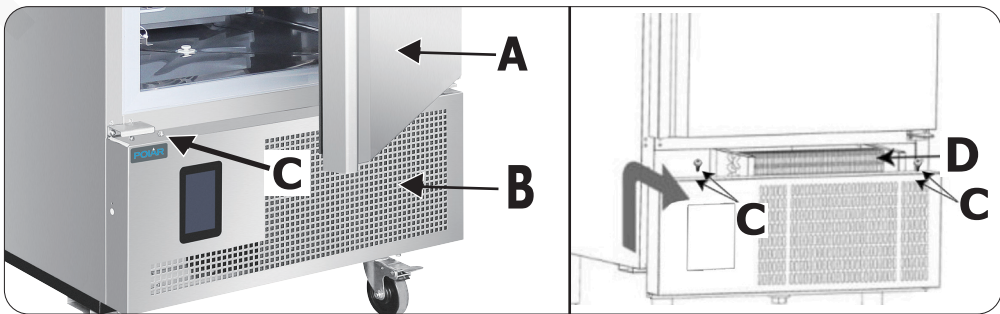

Resolución de problemas

Un técnico calificado debe realizar las reparaciones si es necesario.

Fallo	Causa probable	Acción
El aparato no funciona	El aparato no está conectado	Compruebe que el aparato esté enchufado correctamente y conectado
	El enchufe y el cable están dañados	Reemplace el enchufe o el cable
	Fallo de la fuente de alimentación de red	Compruebe la fuente de alimentación de red
El aparato tiene fugas de agua	El aparato no está correctamente nivelado	Ajuste los tornillos de las patas para nivelar el aparato (si corresponde)
	El drenaje está obstruido	Limpie la salida de líquido
	El movimiento del agua hacia el desagüe está obstruido	Limpie el suelo interior del aparato
	El contenedor de agua está dañado	Consulte a un técnico cualificado
El aparato tiene ruido inusualmente alto	El aparato no se ha instalado en una posición nivelada o	Compruebe la posición de la instalación y cámbiela si es necesario
	Tuerca/tornillo flojo	Compruebe y apriete todas las tuercas y tornillos
El aparato no enfría	Programa incorrecto	Cambie el programa - vea el manual del controlador
	El filtro está bloqueado	Limpie los filtros
No se detecta la temperatura de los alimentos	La sonda de alimentos está rota	Adquiera una nueva sonda de alimentos de su distribuidor
Los alimentos tienen quemaduras en el congelador después de retirarlos de la unidad	El ciclo seleccionado no es el adecuado para el alimento	Cambie el ciclo de congelación intensa a congelación suave (Selección de un ciclo)
El aparato emite un pitido y aparece un mensaje en el panel de control	Hay un problema con la unidad que se indica mediante la señal de alarma de control	Vea la tabla siguiente

Mensaje/Código del Panel de Control	Significado	Acción Requerida
RTC	Error de Reloj	Reconfigurar la fecha y la hora. Para más detalles, consulte la "Sección 12.1:Servicio" en el Manual del Controlador suministrado con el aparato.
SONDA DEL GABINETE	Error de la sonda del gabinete	<ul style="list-style-type: none"> • Verificar que la sonda no esté dañada. • Verificar la conexión aparato-sonda • Verificar la temperatura del gabinete • Si el problema persiste, llame al Agente POLAR o al Técnico Calificado
SONDA DEL EVAPORADOR	Error de la sonda del evaporador	Igual que para el error de la sonda del gabinete pero con referencia a la sonda del evaporador
SONDA DEL CONDENSADOR	Error de la sonda del condensador	Igual que para el error de la sonda del gabinete pero con referencia a la sonda del condensador
SONDA DE LA AGUJA SENSOR 1/2/3	Error de la sonda aguja/sensor 1/2/3	Igual que para el error de la sonda del gabinete pero con referencia a la sonda de aguja 1/2/3
SONDA DE LA AGUJA	Alarma de la sonda de aguja (todos los sensores de sonda de aguja habilitados están en estado de alarma)	Igual que para el error de la sonda del gabinete pero con referencia a todas las sondas de aguja
SONDA DE LA AGUJA DE INSERCIÓN	Alarma de la sonda de aguja no insertada	Verificar que las sondas de las agujas se han insertado correctamente
PUERTA ABIERTA	Alarma de puerta abierta	Verificar el estado de la puerta
ALTA TEMPERATURA	Alarma de temperatura máxima (alarma HACCP)	Verificar la temperatura del gabinete
BAJA TEMPERATURA	Alarma de temperatura mínima (alarma HACCP)	Verificar la temperatura del gabinete
FALLO DE SUMINISTRO	Alarma de fallo de suministro (alarma HACCP)	Verificar la conexión de suministro del aparato

Nota: Esta tabla sólo enumera alarmas muy básicas. Para más información detallada sobre las alarmas, consulte la "Sección 16 Alarmas" en el Manual del Controlador

Especificaciones Técnicas

Nota: Debido a nuestro proceso de mejora continua, las especificaciones del producto están sujetas a cambios sin previo aviso.

Modelo	Tensión	Potencia	Capacidad	Peso (kg)	Margen de Temperaturas	Refrigerante	Dimensiones a x x p mm
UA014	230V~ 50Hz	700W	3 x GN1/1	104	+5°C ~ -35°C	R290	965 x 804 x 826
UA015		720W	5 x GN1/1	116	+5°C ~ -35°C	R290	1035 x 804 x 826
UA016		900W	10 x GN1/1	150	+5°C ~ -35°C	R290	1885 x 800 x 815

Modelo	Tasa de enfriamiento	Tasa de congelación	Capacidad de carga completa del refrigerador	Capacidad de carga completa del congelador
UA014	90 min. (12kg)	240 min. (8kg)	12kg	8kg
UA015	90 min. (18kg)	240 min. (14kg)	18kg	14kg
UA016	90 min. (40kg)	240 min. (28kg)	40kg	28kg

Cableado Eléctrico

El enchufe tiene que conectarse a una toma eléctrica adecuada.

Este aparato está conectado de la forma siguiente:

- Cable cargado (de color marrón) al terminal marcado como L
- Cable neutro (de color azul) al terminal marcado como N
- Cable de tierra (de color verde / amarillo) al terminal marcado como E

Este aparato debe conectarse a una toma de tierra.



Si tiene alguna duda, consulte a un electricista cualificado.

Los puntos de aislamiento eléctrico deben mantenerse libres de cualquier obstrucción. En caso de precisarse una desconexión de emergencia, deben estar disponibles de forma inmediata.

Desecho

Las normativas de la UE requieren que los productos de refrigeración sean desechados por compañías especializadas que extraigan o reciclen todos los gases, componentes metálicos y de plástico.

Consulte a su autoridad local de recogida de residuos a la hora de desechar su aparato. Las autoridades locales no están obligadas a eliminar los equipos de refrigeración comerciales pero pueden ofrecer consejo sobre cómo desechar los equipos localmente.

Otra opción es llamar a la línea de asistencia de POLAR para pedir información sobre las compañías nacionales de desechos de la UE.

Cumplimiento

El logotipo WEEE en este producto o su documentación indica que no debe eliminarse como un residuo doméstico. Para ayudar a prevenir posibles daños a la salud humana y/ o el medio ambiente, el producto debe eliminarse en un proceso de reciclaje aprobado y medioambientalmente seguro. Para obtener más información sobre cómo eliminar correctamente este producto, póngase en contacto con el proveedor del mismo o la autoridad local responsable de la eliminación de residuos en su zona.



Las piezas POLAR han pasado estrictas pruebas de productos para cumplir las especificaciones y normas reguladoras establecidas por las autoridades internacionales, independientes y federales.



Los productos POLAR han sido autorizados para llevar el símbolo siguiente:

Reservados todos los derechos. Puede estar prohibida la reproducción o transmisión en cualquier forma o por cualquier medio electrónico, mecánico, de fotocopiado, registro o de otro tipo, de cualquier parte de estas instrucciones sin la autorización previa y por escrito de POLAR.

Se ha hecho todo lo posible para garantizar que todos los datos son correctos en el momento de su publicación; sin embargo, POLAR se reserva el derecho a modificar las especificaciones sin que medie notificación previa.

Reversing the door (for Model UA014/UA015)

1. Remove the screws fixing the control panel, then open the panel.

NL: Verwijder de schroeven waarmee het bedieningspaneel is bevestigd en open vervolgens het paneel.
FR: Dévisser les vis de fixation du panneau d'entrée, puis ouvrez le panneau.
DE: Entfernen Sie die Montageschrauben des Bedienfeldes und öffnen das Bedienfeld.
IT: Rimuovere le viti che fissano il pannello di controllo, quindi aprire il pannello.
ES: Retire los tornillos que fijan el panel de control y abra el panel.

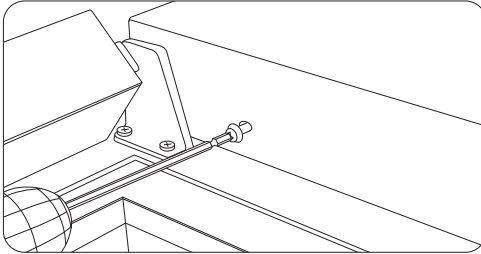

2. Remove the right lower hinge.

NL: Verwijder het scharnier rechts onderaan.
FR: Déverrouiller la charnière basse droite.
DE: Entfernen Sie das rechte untere Scharnier.
IT: Rimuovere il cardine inferiore destro
ES: Retire la bisagra inferior derecha.

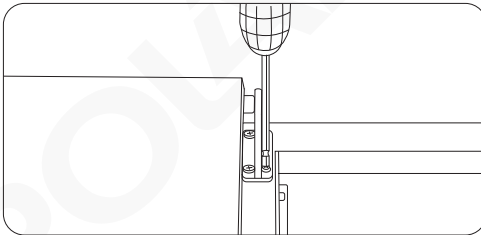

3. Remove the left lower hinge.

NL: Verwijder het scharnier links onderaan.
FR: Déverrouiller la charnière inférieure gauche.
DE: Entfernen Sie das linke untere Scharnier.
IT: Rimuovere il cardine inferiore sinistro.
ES: Retire la bisagra inferior izquierda.

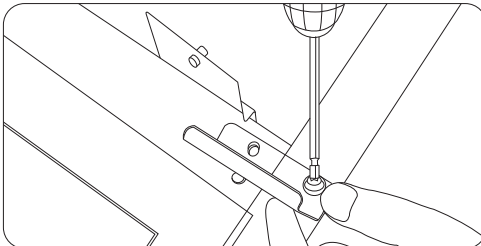

4. Exchange the door spring and hinge bracket.

NL: Vervang de deurveer en de scharnierbeugel.
FR: Remplacer le ressort de la porte et le support de la charnière.
DE: Vertauschen Sie die Türfeder und den Scharnierhalter.
IT: Scambiare la molla della porta e la staffa della cerniera.
ES: Cambie el muelle de la puerta y el soporte de la bisagra.

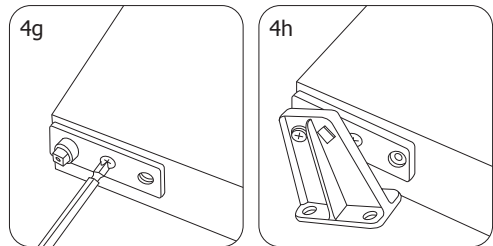
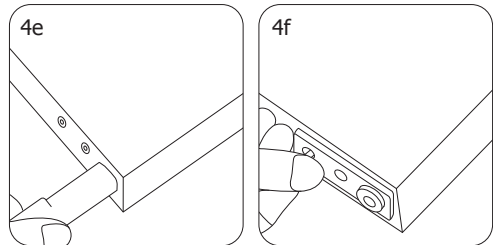
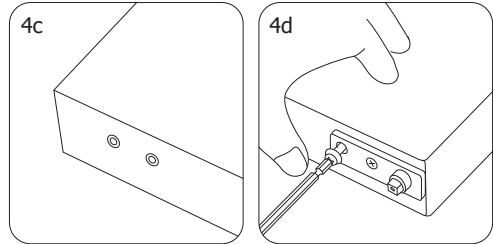
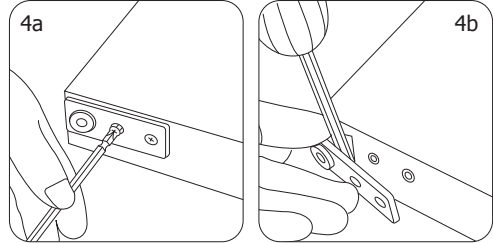

5. Remove the right upper hinge.

- NL: Verwijder het scharnier rechts bovenaan.
FR: Remettre en place la charnière supérieure droite.
DE: Entfernen Sie das rechte obere Scharnier.
IT: Rimuovere il cardine superiore destro.
ES: Desmonte la bisagra superior derecha.

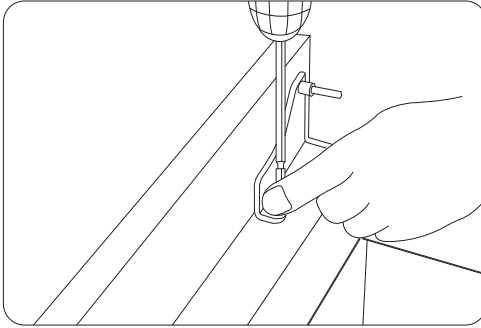

7. Fix the door on the left upper hinge.

- NL: Zet de deur vast op het scharnier links bovenaan.
FR: Fixer la porte sur la charnière supérieure.
DE: Befestigen Sie die Tür an dem linken oberen Scharnier.
IT: Fissare la porta sul cardine superiore sinistro.
ES: Fije la puerta en la bisagra superior izquierda.

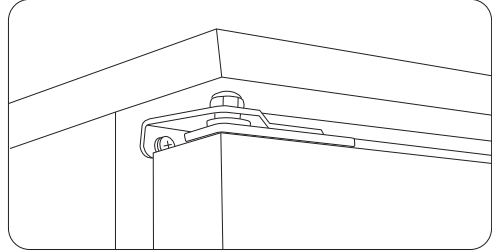

6. Install the left upper hinge (Note: This hinge assembly needs to be purchased separately at code AK134).

- NL: Installeer het scharnier links bovenaan. (Let op: Dit scharnier moet apart worden aangeschaft bij code AK134).
FR: Installer la charnière supérieure droite (Remarque : Cette charnière doit être achetée séparément sous le code AK134).
DE: Montieren Sie das linke obere Scharnier (Hinweis: Diese Scharnierbaugruppe muss separat unter dem Code AK134 erworben werden).
IT: Installare il cardine superiore sinistro (Nota: Questo gruppo cerniera deve essere acquistato separatamente con il codice AK134).
ES: Instale la bisagra superior izquierda (Nota: Este conjunto de bisagra debe adquirirse por separado con el código AK134).

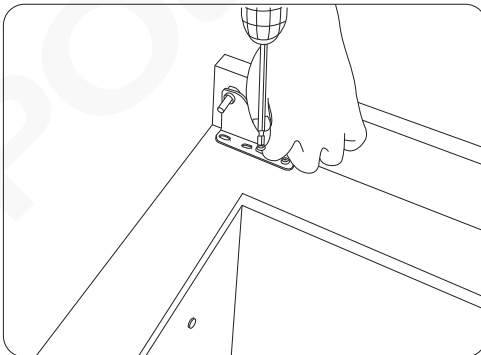

8. Fix the door on the left lower hinge.

- NL: Zet de deur vast op het scharnier links onderaan.
FR: Fixer la porte sur la charnière inférieure.
DE: Befestigen Sie die Tür am linken unteren Scharnier.
IT: Fissare la porta sul cardine inferiore sinistro.
ES: Fije la puerta en la bisagra inferior izquierda.

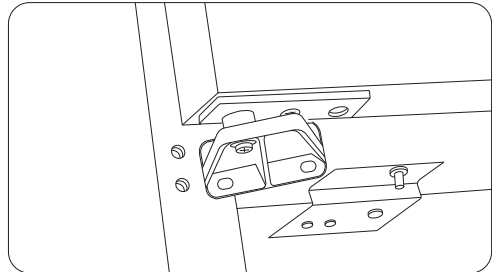

9. Re-locate the control panel and fix it in place with the previously removed screws.

- NL: Plaats het bedieningspaneel terug en bevestig het op zijn plaats met de eerder verwijderde schroeven.
FR: Remettre le panneau de commande en place et le fixer en place avec les vis enlevées précédemment.
DE: Setzen Sie das Bedienfeld wieder ein und befestigen es mit den zuvor entfernten Schrauben.
IT: Riposizionare il pannello di controllo e fissarlo in posizione con le viti precedentemente rimosse.
ES: Vuelva a colocar el panel de control y fíjelo en su lugar con los tornillos retirados anteriormente.

Reversing the door (for Model UA016)

1. Remove the screws fixing the control panel, then open the panel.

NL: Verwijder de schroeven waarmee het bedieningspaneel is bevestigd en open vervolgens het paneel.

FR: Dévisser les vis de fixation du panneau de commande, puis ouvrir le panneau.

DE: Entfernen Sie die Montageschrauben des Bedienfeldes und öffnen das Bedienfeld.

IT: Rimuovere le viti che fissano il pannello di controllo, quindi aprire il pannello.

ES: Retire los tornillos que fijan el panel de control y abra el panel.

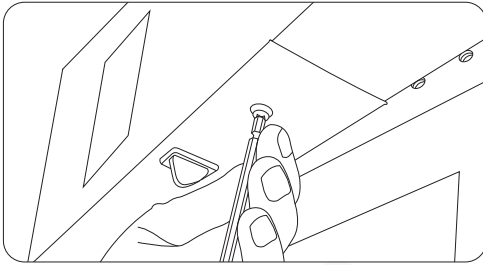

2. Remove the right upper hinge.

NL: Verwijder het scharnier rechts bovenaan.

FR: Dévisser la charnière supérieure droite.

DE: Entfernen Sie das rechte obere Scharnier.

IT: Rimuovere il cardine superiore destro.

ES: Retire la bisagra superior derecha.

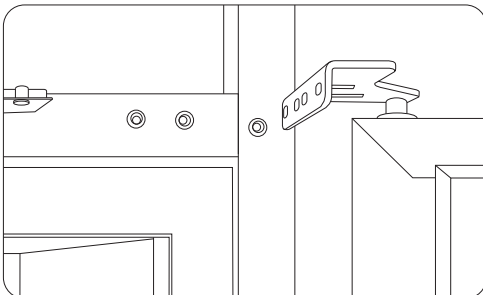
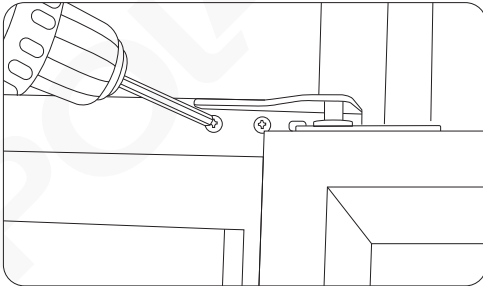

3. Remove the right lower hinge.

NL: Verwijder het scharnier rechts onderaan.

FR: Retirer la charnière inférieure droite.

DE: Entfernen Sie das rechte untere Scharnier.

IT: Rimuovere il cardine inferiore destro.

ES: Retire la bisagra inferior derecha.

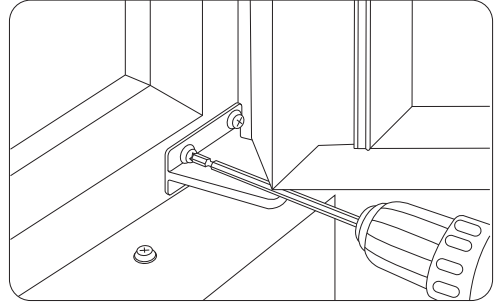

4. Remove the left lower hinge.

NL: Verwijder het scharnier links onderaan.

FR: Retirer la charnière inférieure gauche.

DE: Entfernen Sie das linke untere Scharnier.

IT: Rimuovere il cardine inferiore sinistro.

ES: Retire la bisagra inferior izquierda.

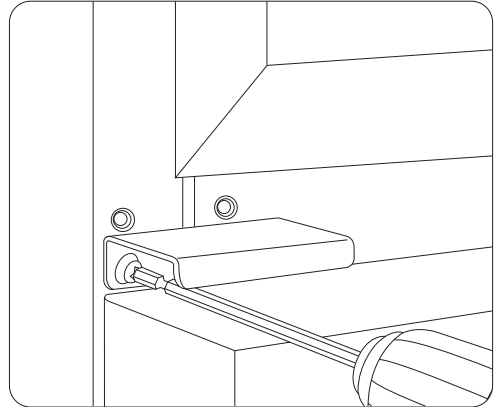

5. Exchange the door spring and door bushing.

NL: Vervang de deurveer en de doorvoering van de deur.
FR: Remplacer le ressort de la porte et la bague de la porte.
DE: Vertauschen Sie die Türfeder und die Türbuchse.
IT: Scambiare la molla della porta e la boccola della porta.
ES: Cambie el muelle y el casquillo de la puerta.

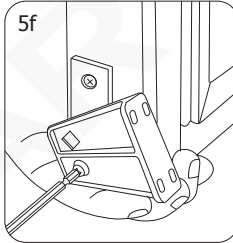
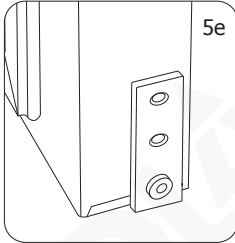
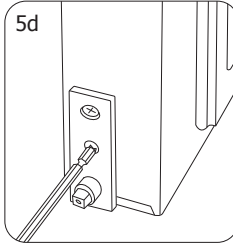
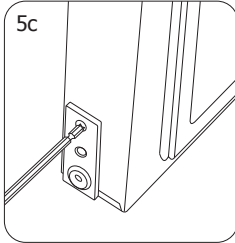
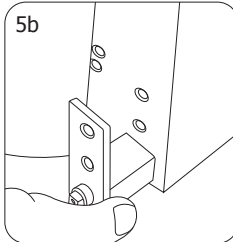
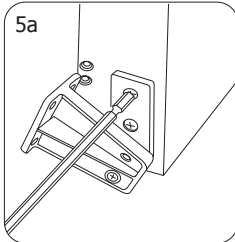

6. Install the left lower hinge (previously removed in step4) on the right side.

NL: Verwijder het scharnier links onderaan (eerder in stap 4 verwijderd) aan de rechter kant.
FR: Retirer la charnière inférieure du côté droit (retirée précédemment dans l'étape 2).
DE: Montieren Sie das linke untere Scharnier (zuvor in Schritt 4 entfernt) auf der rechten Seite.
IT: Installare il cardine inferiore sinistro (precedentemente rimosso al punto 4) sul lato destro.
ES: Instale la bisagra inferior izquiera (retirada previamente en el paso4) en el lado derecho.

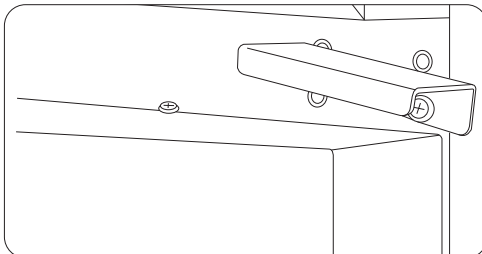

7. Fix the door on the left lower hinge.

NL: Zet de deur vast op het scharnier links onderaan.
FR: Fixer la porte sur la charnière inférieure de la porte.
DE: Befestigen Sie die Tür auf dem linken unteren Scharnier.
IT: Fissare la porta sul cardine inferiore sinistro.
ES: Fije la puerta en la bisagra inferior izquierda.

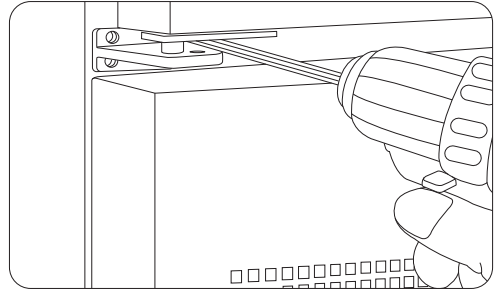

8. Install the left upper hinge (Note: This hinge assembly needs to be purchased separately at code AM282). Mount the door on the hinge.

NL: Installeer het linker bovenste scharnier (Opmerking: dit scharnier moet apart worden gekocht met code AM282). Monteer de deur op het scharnier.
FR: Installer la charnière supérieure gauche (Note : Cette charnière doit être achetée séparément au code AM282). Monter la porte sur la charnière.
DE: Montieren Sie das linke obere Scharnier (Hinweis: Diese Scharnierbaugruppe muss separat unter Code AM282 erworben werden). Montieren Sie die Tür auf das Scharnier.
IT: Installare la cerniera superiore sinistra (Nota: questo gruppo di cerniere deve essere acquistato separatamente con il codice AM282). Montare la porta sulla cerniera.
ES: Instale la bisagra superior izquierda (Nota: Este conjunto de bisagra debe adquirirse por separado con el código AM282). Monte la puerta en la bisagra.

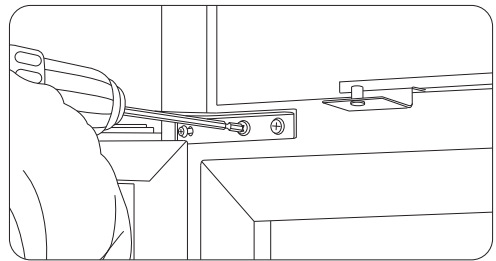

9. Re-locate the control panel and fix it in place with the previously removed screws.

NL: Plaats het bedieningspaneel terug en bevestig het op zijn plaats met de eerder verwijderde schroeven.
FR: Remettre le panneau de commande en place et le fixer en place avec les vis précédemment retirées.
DE: Setzen Sie das Bedienfeld wieder ein und befestigen es mit den zuvor entfernten Schrauben.
IT: Riposizionare il pannello di controllo e fissarlo in posizione con le viti precedentemente rimosse.
ES: Vuelva a colocar el panel de control y fíjelo en su lugar con los tornillos que retiró anteriormente.

DECLARATION OF CONFORMITY

- Conformanceverklaring • Déclaration de conformité • Konformitätserklärung • Dichiarazione di conformità •
• Declaración de conformidad

Equipment Type • Uitrustingstype • Type d'équipement • Gerätetyp • Tipo di apparecchiatura • Tipo de equipo	Model • Modèle • Modell • Modello • Modelo
Blast Chiller 3 x 1/1GN - with Touchscreen Controller Blast Chiller 5 x 1/1GN - with Touchscreen Controller Blast Chiller 10 x 1/1GN - with Touchscreen Controller	UA014 (-E & -A) UA015 (-E & -A) UA016 (-E & -A)
Application of Territory Legislation & Council Directives(s) Toepassing van Europese Richtlijn(en) • Application de la/des directive(s) du Conseil • Anwendbare EU-Richtlinie(n) • Applicazione delle Direttive • Aplicación de la(s) directiva(s) del consejo	<p>Machinery Directive 2006/42/EC Supply of Machinery (Safety) Regulations 2008 EN 60335-1:2012 +A11:2014 +A13:2017 +A1:2019 +A14:2019 +A2:2019 EN 60335-2-89:2010 +A1:2016 +A2:2017 EN62233:2008</p> <p>Electro-Magnetic Compatibility (EMC) Directive 2014/30/EU - recast of 2004/108/EC Electromagnetic Compatibility Regulations 2016 (S.I. 2016/1091) EN IEC 55014-1: 2021 EN IEC 55014-2: 2021 EN IEC 61000-3-2: 2019+A1:2021 EN IEC 61000-3-11: 2019</p> <p>Restriction of Hazardous Substances Directive (RoHS) 2015/863 amending Annex II to Directive 2011/65/EU Restriction of the Use of Certain Hazardous Substances in Electrical and Electronic Equipment Regulations 2012 (S.I. 2012/3032)</p> <p>Electrical Safety IEC 60335-1:2010 +A1:2013 +A2:2016 IEC 60335-2-89:2010 +A1:2012 +A2:2015</p> <p>Electromagnetic Compatibility EN IEC 55014-1: 2021 EN IEC 55014-2: 2021 EN IEC 61000-3-2: 2019+A1:2021 EN IEC 61000-3-11: 2019</p>
Manufacturer Name • Naam fabrikant • Nom du fabricant • Name des Herstellers • Nome del fabbricante • Nombre del fabricante	Polar

I, the undersigned, hereby declare that the equipment specified above conforms to the above Territory Legislation, Directive(s) and Standard(s).

Ik, de ondergetekende, verklaar hierbij dat de hierboven gespecificeerde uitrusting goedgekeurd is volgens de bovenstaande Richtlijn(en) en Standaard(en).

Je soussigné, confirme la conformité de l'équipement cité dans la présente à la / aux Directive(s) et Norme(s) ci-dessus

Ich, der/die Unterzeichnende, erkläre hiermit, dass das oben angegebene Gerät der/den oben angeführten Richtlinie(n) und Norm(en) entspricht.

Il sottoscritto dichiara che l'apparecchiatura di sopra specificata è conforme alle Direttive e agli Standard sopra riportati.

El abajo firmante declara por la presente que el equipo arriba especificado está en conformidad con la(s) directiva(s) y estándar(es) arriba mencionadas.

Date • Data • Date • Datum • Data •

Fecha

Signature • Handtekening •

Signature • Unterschrift Firma •

Firma

Full Name • Volledige naam • Nom et prénom

• Vollständiger Name • Nome completo •

Nombre completo

Position • Functie • Fonction • Position •

Qualifica • Posición

Manufacturer Address • Adres fabrikant •

Adresse du fabricant • Adresse des Herstellers

• Indirizzo del fabbricante • Dirección del

fabricante

16th Jul 2024

DocuSigned by: <i>Ashley Hooper</i> B39382C9FD9C478...	DocuSigned by: <i>Eoghan Donnellan</i> D3528747FFAB460...	DocuSigned by: <i>Brendan</i> 386FAD00DFE8483...
Ashley Hooper	Eoghan Donnellan	Brendan Denmeade
Group Head of Product Quality & Compliance	Commercial Manager/Importer	Commercial Manager/Responsible Supplier
Fourth Way, Avonmouth, Bristol, BS11 8TB United Kingdom	Unit 9003, Blarney Business Park, Blarney, Co. Cork Ireland	15 Badgally Road, Campbelltown NSW 2560





UK	0117 3075655	Service@technical-sales.co.uk
Eire	021 4946777	Sale@nisbets.ie
NL	040 2628080	Service@nisbets.nl
FR	01 60342880	sav@nisbets.fr
BE-NL	0800-29129	Service@nisbets.be
BE-FR	0800-29229	Service@nisbets.be
DE	0800 1860806	Service@nisbets.de
ES	901 100 133	
AU	1300 225 960	
NZ	0800 222 700	

POLAR



<http://www.polar-refrigerator.com/> 

UA014-UA015-UA016_ML_A5_v4_2025/05/27



Vcolor 869

Controllers for blast chillers with customizable graphical skin



ENGLISH

INSTALLER MANUAL ver. 1.0

CODE 144VC869E04

Important



Read this document carefully before installation and before using the device and take all the prescribed precautions.

Keep this document with the device for future consultation.

Only use the device in the ways described in this document. Do not use the device as safety device.

The following symbols are used in this document:

💡 indicates a suggestion

⚠ indicates a warning.



Disposal

The device must be disposed of according to local regulations governing the collection of electrical and electronic waste.

Index

- 1 INTRODUCTION6
 - 1.1 Introduction6
 - 1.2 Main features of the models available7
- 2 DESCRIPTION.....10
 - 2.1 User interface description.....10
 - 2.2 Control module description.....12
- 3 MEASUREMENTS AND INSTALLATION13
 - 3.1 Vcolor 869M user interface measurements13
 - 3.2 Vcolor 869L user interface measurements13
 - 3.3 Control module measurements14
 - 3.4 Multi-functional module measurements.....14
 - 3.5 User interface installation.....15
 - 3.6 Control and multi-functional module installation.....16
 - 3.7 Installation precautions.....16
- 4 ELECTRICAL CONNECTION17
 - 4.1 Electrical connection of Vcolor 869M.....17
 - 4.2 Electrical connection of Vcolor 869L.....19
 - 4.3 Precautions for electrical connection20
- 5 USER INTERFACE21
 - 5.1 Initial information21
 - 5.2 Initial switch-on.....21
 - 5.3 Switching the device on and off23
 - 5.4 Lock/unlock keypad.....23
 - 5.5 Silencing the buzzer23
 - 5.6 Door-open signal.....23
- 6 OPERATION24
 - 6.1 Initial information on operating cycles24
 - 6.2 Initial information on the needle probe24
 - 6.3 Selecting the operating mode25
- 7 BLAST CHILLING.....26
 - 7.1 Blast chilling/blast-freezing and conservation27
 - 7.1.1 Combined cycle with slow cooking29
 - 7.2 Hard blast chilling/soft blast-freezing and conservation.....29
 - 7.3 Continuous cycle.....30
 - 7.3.1 Multineedle probe mode30
 - 7.3.2 Multi-timer mode.....31
 - 7.4 Customized cycle32
 - 7.5 Setting the set points33
 - 7.5.1 Setting the cabinet temperature set point.....33
 - 7.5.2 Setting the product temperature set point33
 - 7.5.3 Setting the cycle duration.....33
 - 7.5.4 Setting the fan speed.....33
 - 7.6 Running the cycle.....34
 - 7.6.1 Needle probe insertion test.....34
 - 7.6.2 Recording historical data35
 - 7.6.3 Cycle end35
- 8 SPECIAL CYCLES.....37

8.1	Fish sanitation	38
8.2	Thawing	40
8.3	Defrosting	42
8.4	Ice cream hardening.....	43
8.5	Cabinet sterilisation.....	44
8.6	Heating the needle probe	45
8.7	Drying	45
8.8	Retarding proofing	46
8.8.1	Description of retarding proofing	46
8.8.2	Setting up a retarding proofing cycle	48
8.9	Slow cooking	50
8.10	Conservation	52
9	RECIPE BOOK	53
9.1	"COOKBOOK" recipe book	53
9.2	"MY COOKBOOK" recipe book	54
9.2.1	Saving "MY COOKBOOK" recipes	54
9.2.2	Starting "MY COOKBOOK" recipes.....	56
9.2.3	Deleting "MY COOKBOOK" recipes	56
10	PRE-COOLING.....	57
11	ADJUSTMENTS.....	58
11.1	Door frame heating output	58
11.2	Compressor management.....	58
11.3	Gestione secondo compressore	59
11.4	Pump down solenoid valve management	59
11.5	Evaporator fan management.....	59
11.6	Condenser fan management	61
11.7	Alarm output management.....	61
11.8	Needle probe heating management	61
11.9	Cabinet sterilisation management.....	61
11.10	Defrost output management	61
11.11	Thawing heater management.....	62
11.12	Proofing and slow cooking heater management.....	62
11.13	Humidifier management.....	62
11.14	Humidifying/steam generator heater management	62
11.15	Cabinet light management.....	62
12	SETTINGS	63
12.1	Time and date	63
12.2	Service	63
12.3	Internal values.....	63
12.4	Select language	63
13	USING THE USB PORT	64
13.1	Initial information.....	64
13.1.1	Uploading program settings (USB → controller).....	64
13.1.2	Downloading program settings (controller -> USB)	64
13.1.3	Uploading configuration parameter settings (USB → controller)	64
13.1.4	Downloading configuration parameter settings (controller -> USB)	65
13.1.5	Downloading HACCP data (controller -> USB)	65
14	EPOCA CLOUD PLATFORM	66
15	LIST OF CONFIGURATION PARAMETERS	67

16 ALARMS 79

 16.1 Alarms 79

 16.2 HACCP alarms..... 84

17 ACCESSORIES 85

 17.1 EVC20P52N9XXX10 - Multi-functional module 85

 17.2 ECTSFD004 - 230 VAC/12 VAC 20 VA safety transformer 85

 17.3 EVIF20SUXI - Non-optoisolated RS-485/USB serial interface 85

 17.4 0812000002 - USB plug for panel installation 86

 17.5 0810500018/0810500020 - Connecting cables 86

 17.6 EVDFAN1 - Phase cutting speed regulator for single-phase fans 86

 17.7 EVUSB4096M - 4GB USB flash drive 87

 17.8 EVIF25SWX – EVlink Wi-Fi RS485 module 87

18 TECHNICAL SPECIFICATIONS 88

 18.1 Technical specifications 88

1 INTRODUCTION

1.1 Introduction

Vcolor 869 manages all the most up-to-date functions of state-of-the-art blast chillers. Besides the traditional blast-chilling and blast-freezing cycles, temperature and time controlled with hard/soft function, the controller can manage up to 12 special cycles, 4 types of combined cycles, as well as the needle insertion test (including multipoint needle probes).

An expansion module makes it possible to transform the blast chiller into a multi-functional machine for managing retarding-proofing and slow cooking cycles.

The controller has intuitive navigation with graphical monitoring of cycles in progress and its innovative programmable platform enables to independently personalise the graphical skin to an advanced degree, to set up the recipe book with high quality photographs and to add new machine interface languages.

On demand, the controllers can be equipped with Wi-Fi connectivity to interact remotely with the unit through the EPoCA cloud platform, with option to start/stop working cycles.

Available in a 5 or 7-inch split version with a capacitive colour TFT touch-screen graphic display, the user interface can be installed flush with the panel thus making it fit perfectly with the design of the unit.

1.2 Main features of the models available

La seguente tabella illustra le caratteristiche principali dei modelli disponibili e i codici di acquisto.

MAIN FEATURES	AVAILABLE MODELS/KITS		OPTIONS		
	Vcolor 869M (5")	Vcolor 869L (7")	Expansion module	Speed regulator	EVlink Wi-Fi
	EVCMC869P9E	EVCLC869P9E	EVC20P52N9XXX10	EVDfan1	EVIF25SWX
Power supply					
control module	115... 230 VAC	115... 230 VAC			
user interface	powered by control module	12 VAC			
additional modules			115...230 VAC	230 VAC	powered by control module
Analogue inputs					
cabinet probe	PTC/NTC	PTC/NTC			
needle probe (sensor 1)	PTC/NTC	PTC/NTC			
needle probe (sensor 2)	PTC/NTC	PTC/NTC			
needle probe (sensor 3)	PTC/NTC	PTC/NTC			
evaporator probe	PTC/NTC	PTC/NTC			
condenser probe	PTC/NTC	PTC/NTC			
Digital inputs					
door switch	•	•			
compressor thermal switch	•	•			
low pressure switch	•	•			
high pressure switch	•	•			
Other inputs					
PWM drive signal				•	
Analogue outputs ⁽¹⁾					
PWM, for speed regulators (evaporator fan)	•	•			

MAIN FEATURES	AVAILABLE MODELS/KITS		OPTIONS		
	Vcolor 869M (5")	Vcolor 869L (7")	Expansion module	Speed regulator	EVlink Wi-Fi
	EVCMC869P9E	EVCLC869P9E	EVC20P52N9XXX10	EVDfan1	EVIF25SWX
Digital outputs electro-mechanical relays; A res. @ 250 VAC (configurable)					
compressor	30 A	30 A			
defrost	8 A	8 A			
evaporator fan	8 A	8 A			
condenser fan	8 A	8 A			
door heater	8 A	8 A			
thawing heater	16 A	16 A			
alarm (configurable) (1)	16 A	16 A			
pump down valve (configurable) (2)	8 A	8 A			
needle probe heater (configurable) (3)	8 A	8 A			
cabinet heater			30 A		
steam generator			16 A		
steam injection			8 A		
auxiliary output			16 A		
Other outputs					
phase cutting				•	
Communications ports					
RS-485 MODBUS	•	•		•	
USB	•	•			

MAIN FEATURES	AVAILABLE MODELS/KITS		OPTIONS		
	Vcolor 869M (5")	Vcolor 869L (7")	Expansion module	Speed regulator	EVlink Wi-Fi
	EVCMC869P9E	EVCLC869P9E	EVC20P52N9XXX10	EVDFAN1	EVIF25SWX
Other features					
clock	•	•			•
alarm buzzer	•	•			
management of positive and negative blast chilling cycles, both temperature and time controlled	•	•			
management of blast chilling intensity				•	
management of multipoint or multineedle probes	•	•			
management of special cycles (fish sanitation, thawing and ice cream hardening)	•	•			
management of retarding-proofing and slow cooking special cycles.			•		
recording HACCP data and graphics processing in real time	•	•			•
ready-to-use OEM recipes and storage of user recipes	•	•			
Wi-Fi connectivity for remote management through EPoCA portal					•

⁽¹⁾ If a PWM speed regulator is present and enabled (parameter E16=1), the evaporator fan speed management will be active and displayed. If the speed regulator is not present, parameter E16 shall be set to 0.

2 DESCRIPTION

2.1 User interface description

The diagram below shows the front view of the user interface in the vertical format

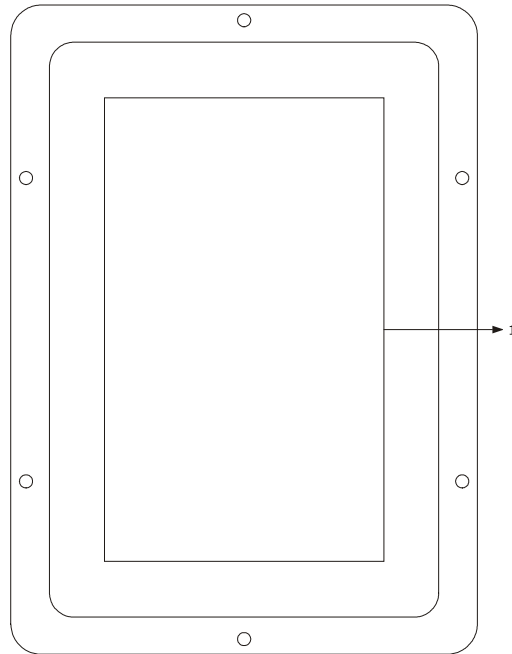

PART	DESCRIPTION
1	display

The diagram below shows the intended use of the user interface connectors.

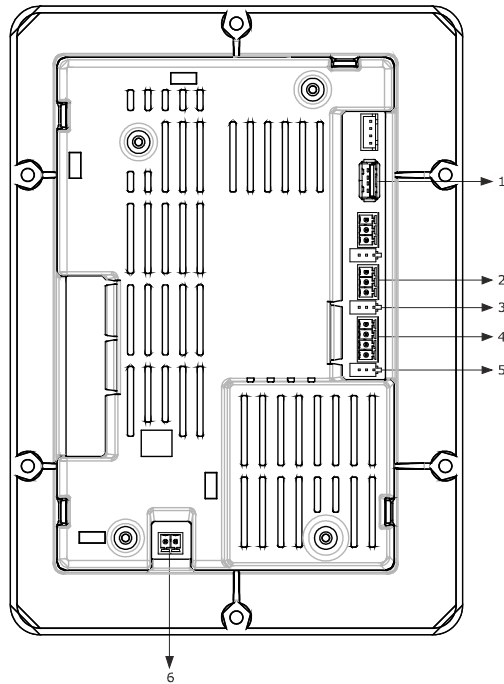

PART	DESCRIPTION
1	USB port
2	RS-485 MODBUS port
3	dip switch for the termination resistor for the RS-485 MODBUS port
4	power supply for the user interface and connection between the user interface and the control module
5	dip switch for the resistor connecting the user interface and the control module
6	appliance earthing

For more information see subsequent sections.

2.2 Control module description

The diagram below shows the intended use of the control module connectors.

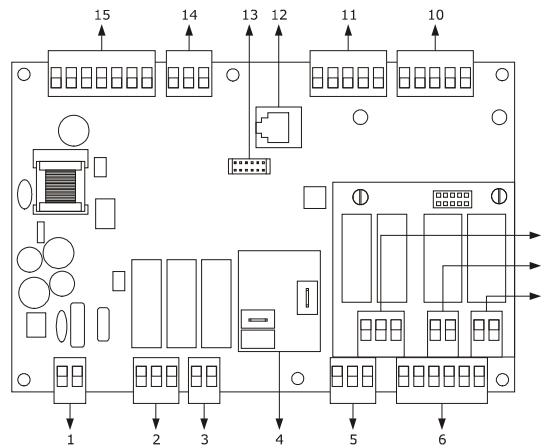

PART	DESCRIPTION
1	control module power supply
2	evaporator fan and condenser fan relay
3	defrost relay
4	compressor relay
5	door heater relay
6	door switch, low pressure switch and high pressure switch, compressor thermal switch
7	thawing heater relay
8	alarm relay
9	pump down relay and needle probe heater
10	cabinet, evaporator and condenser probe
11	multi-point probe or needle probes (up to 3 sensors)
12	unused
13	unused
14	output for phase cutting speed regulator for EVDFAN1 single-phase fans
15	user interface – control module connection

For more information see subsequent sections.

3 MEASUREMENTS AND INSTALLATION

3.1 Vcolor 869M user interface measurements

The picture below shows the measurements of the 5-inch user interface; measurements are expressed in mm (inches).

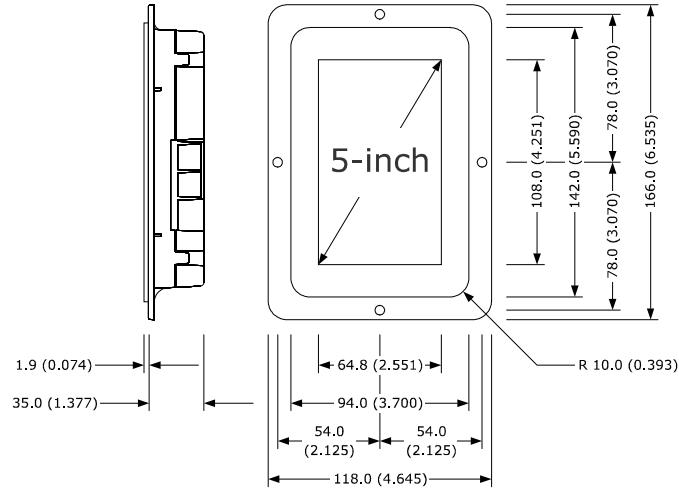

3.2 Vcolor 869L user interface measurements

The picture below shows the measurements of the 7-inch user interface; measurements are expressed in mm (inches).

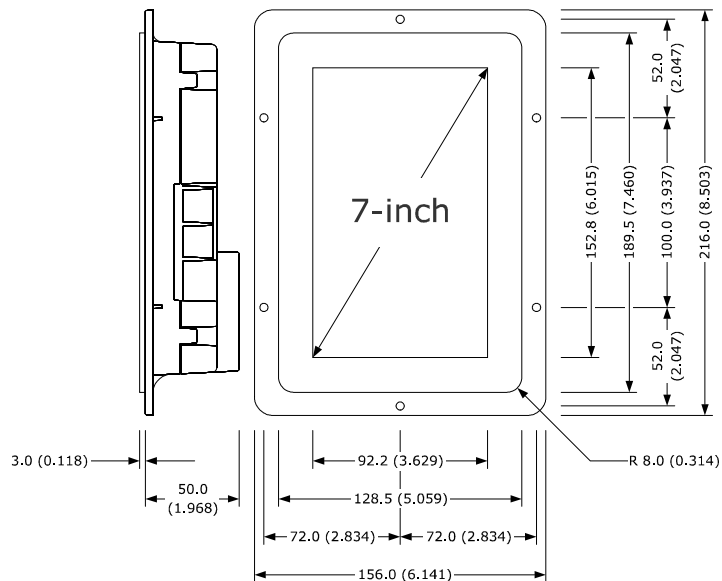

3.3 Control module measurements

The picture below shows the measurements of the **Vcolor 819** control module; measurements are expressed in mm (inches).

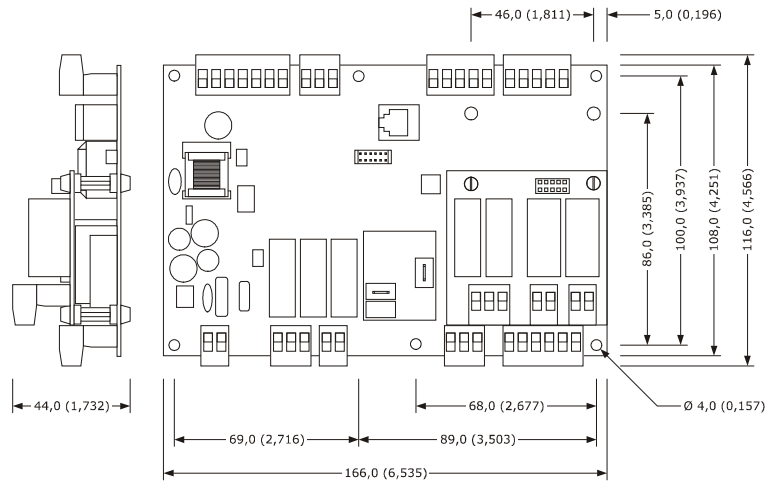

3.4 Multi-functional module measurements

The picture below shows the measurements of the **Vcolor 819** multi-functional module; measurements are expressed in mm (inches).

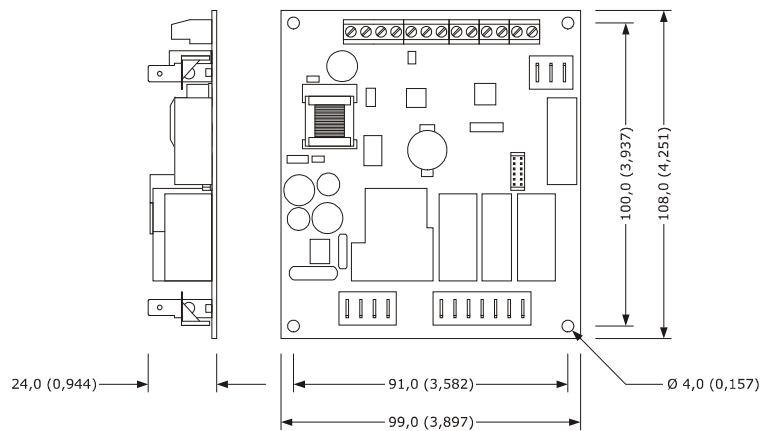

3.5 User interface installation

Mounting of 7" interfaces (Vcolor 869 L):

- Flush-fit installation, from behind the panel using threaded studs

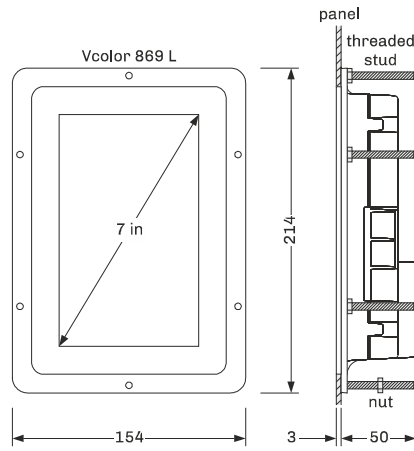

Mounting of 5" interfaces (Vcolor 869 M):

- Flush-fit installation, from behind the panel using threaded studs

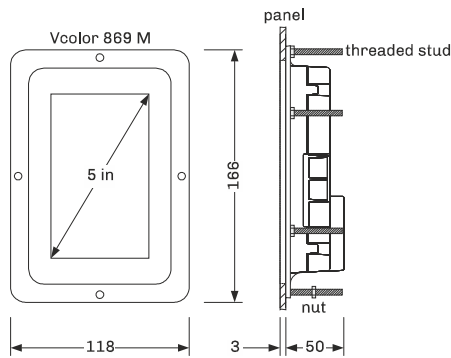

- From the front of the panel, with hooks

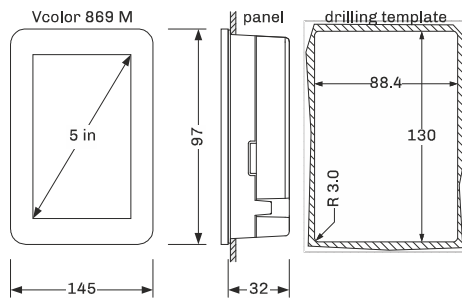

3.6 Control and multi-functional module installation

On a flat surface with spacers.

3.7 Installation precautions

- Ensure that the working conditions for the device (operating temperature, humidity, etc.) are within the set limits. See section 16 TECHNICAL SPECIFICATIONS.
- Do not install the device close to heat sources (heaters, hot air ducts, etc.), equipment with a strong magnetic field (large diffusers, etc.), in places subject to direct sunlight, rain, damp, excessive dust, mechanical vibrations or shocks.
- Any metal items close to the control module must be at a sufficient distance so as not to compromise the safety distance; any cabling must be placed at least 2 cm away.
- In compliance with safety regulations, the device must be installed properly to ensure adequate protection from contact with electrical parts. All protective parts must be fixed in such a way as to need the aid of a tool to remove them.

4 ELECTRICAL CONNECTION

4.1 Electrical connection of Vcolor 869M

The picture below shows the electrical connection of the controller with 5-inch display.

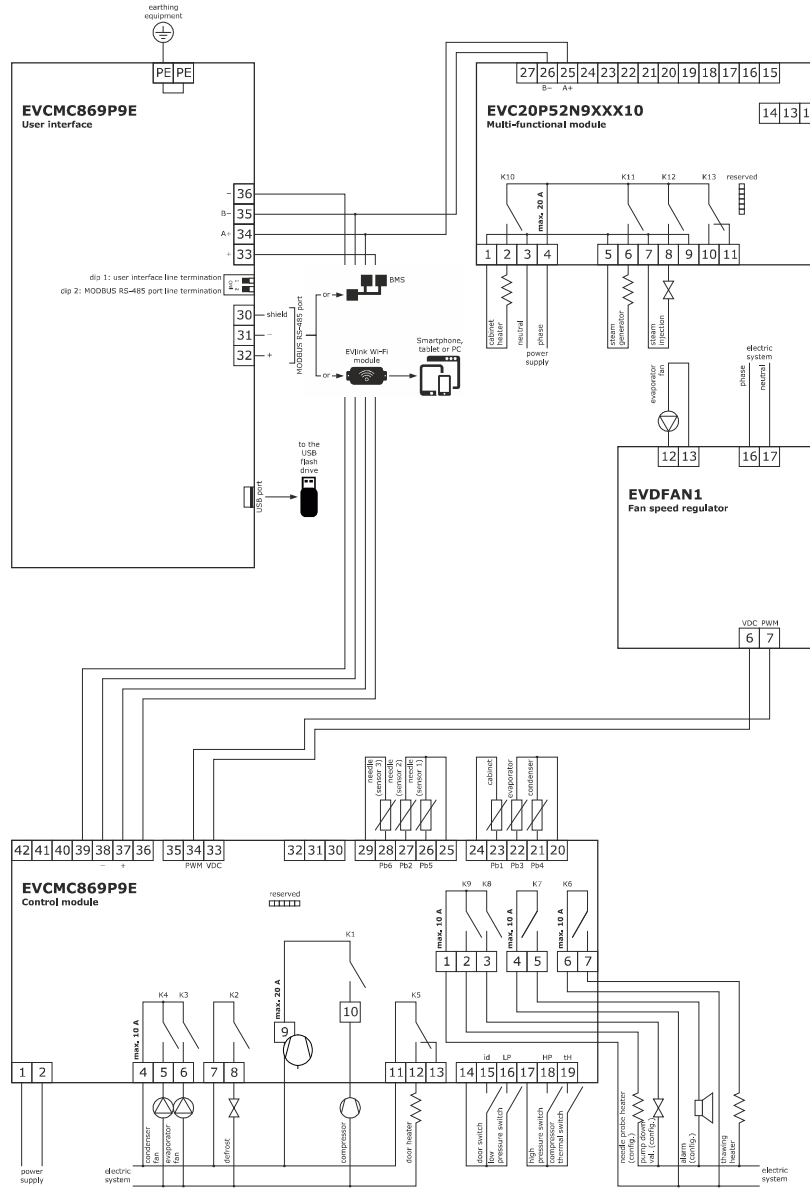

Details of EVlink Wi-Fi electrical connection

Vcolor 869M
User interface

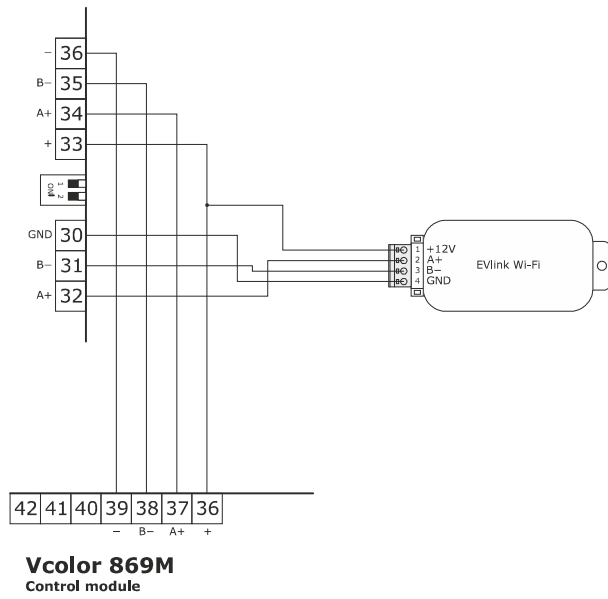

4.2 Electrical connection of Vcolor 869L

The picture below shows the electrical connection of the controller with 7-inch display.

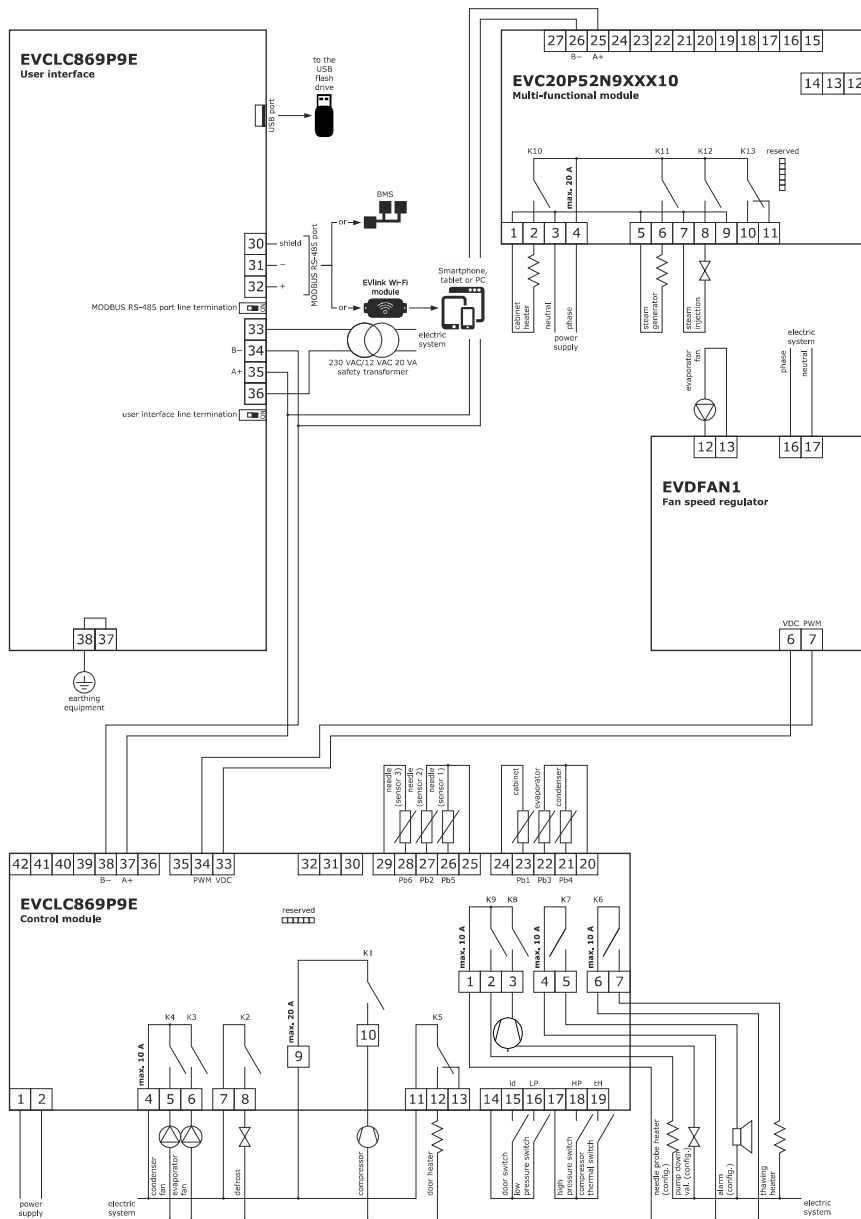

Details of EVlink Wi-Fi electrical connection

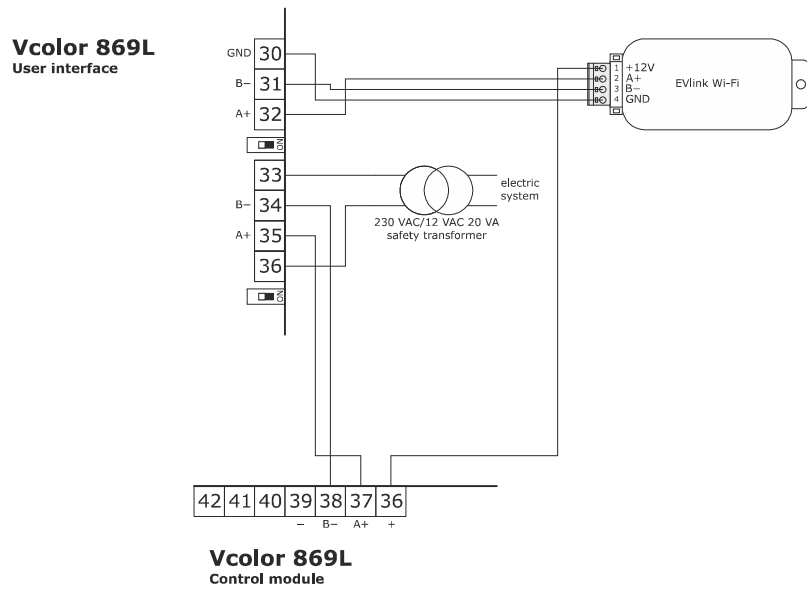

4.3 Precautions for electrical connection

- Do not use electric or pneumatic screwdrivers on the terminal blocks of the device.
- If the device has been moved from a cold to a warm place, the humidity may cause condensation to form inside. Wait about an hour before switching on the power.
- Make sure that the supply voltage, electrical frequency and power of the device correspond to the local power supply. See section 17 TECHNICAL SPECIFICATIONS.
- Disconnect the device from the power supply before doing any type of maintenance.
- Do not use the device as safety device.
- For repairs and for further information on the device, contact the EVCO sales network.

5 USER INTERFACE

5.1 Initial information

The interface has the following operating modes:

- "off" (no power to the device);
- "stand-by" (the device is powered but switched off);
- "on" (the device is powered, switched on and awaiting start-up of an operating cycle);
- "run" (the device is powered, switched on and running an operating cycle).

Terminology: "switch on the device" means moving from "stand-by" to "on" mode and "switch off the device" means moving from "on" to "stand-by" mode.

If the power supply fails during "stand-by" or "on" mode, when power is restored the device will return to the mode set before the failure.

If the power supply fails during "run" mode, when power is restored the device will operate as follows:

- if blast chilling or blast-freezing was in progress, the cycle will resume, taking into account the duration of the power loss;
- if a conservation cycle was running, this will continue using the same settings;
- if a proofing or slow cooking cycle was running, the cycle will continue where it left off.

5.2 Initial switch-on

Connect the power supply to the device: if parameter E9 is set at 1, the device will show the splash screen as defined in the customized graphical skin; if the parameter is set at 0, a system loading screen will be shown:

E9=0

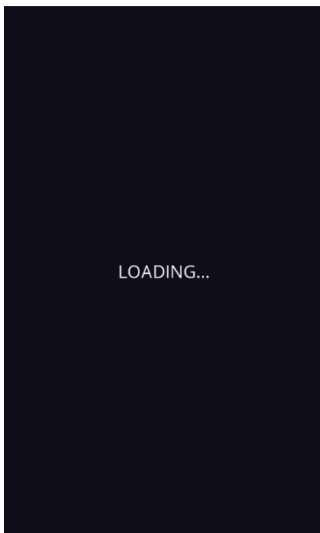

E9=1



Once loading is complete, the device will display the mode it was in before being powered down:

- On/Stand-by screen, press the central area to move to the Home screen;

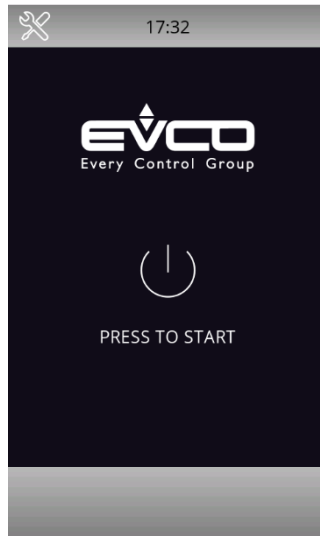

- directly the Home screen. Based on how the machine is configured through parameter "E13", the Home screen will display either the menu of the BLAST CHILLER mode or the menu of the MULTIFUNCTION mode.

Blast chiller mode home screen



Multifunction mode home screen

Page 1

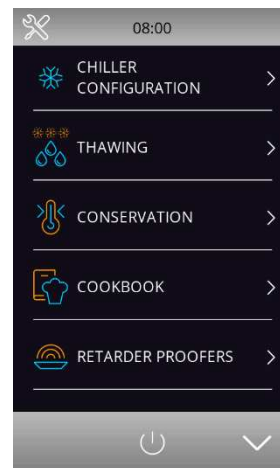

Page 2

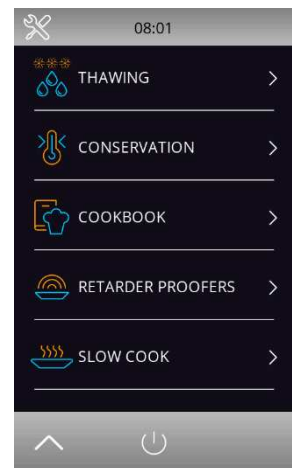

Δ If the power supply has been cut off long enough to cause a clock error (**RTC** code), it will be necessary to reset the date and time. The date and time can be set from the settings screen, service section (paragraph 12.1).

5.3 Switching the device on and off



To switch the device on, press the central area in the On/Stand-by screen and the Home screen will open.



To switch the device off, press the red area at the bottom of the Home screen.

5.4 Lock/unlock keypad

The keypad can be locked by setting parameter E7 to 1, locking the keypad after the period of inactivity set by parameter E8.

If the keypad is locked, a pop-up will appear when it is touched indicating that it is locked and how to unlock it. It can be unlocked by dragging a finger to the right.

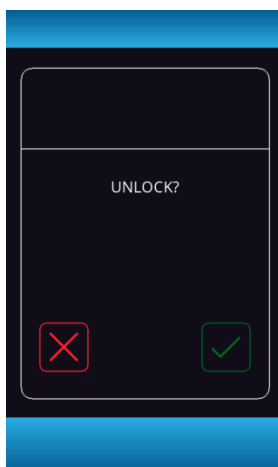

5.5 Silencing the buzzer

Press any key while the buzzer is sounding.

5.6 Door-open signal

When the door is opened the signal shown below will appear on the display.

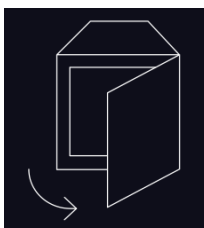

Press any area on the display to remove this signal.

6 OPERATION

6.1 Initial information on operating cycles

The device is capable of operating in the following modes:

- temperature controlled blast chilling and conservation
- hard temperature controlled blast chilling and conservation
- time controlled blast chilling and conservation
- hard time controlled blast chilling and conservation
- temperature controlled blast-freezing and conservation
- soft temperature controlled blast-freezing and conservation
- time controlled blast-freezing and conservation
- soft time controlled blast-freezing and conservation
- multineedle probe continuous cycle
- multi-timer continuous cycle
- pre-cooling
- fish sanitation
- thawing
- defrosting
- ice cream hardening
- sterilisation
- heating the needle probe
- drying

Upon use of the optional expansion module, the following functions are also available:

- proofing
- slow cooking

For more information see the subsequent sections.

6.2 Initial information on the needle probe

This device is capable of managing multipoint needle probes (with up to three sensors) or multineedle probes (up to three probes).

To set the type of probe to be used, configure parameter P3:

- P3=0 no needle probe;
- P3=1 a single needle probe;
- P3=2 multineedle probe (multiple independent needle probes);
- P3=3 multipoint needle probe (multiple sensors in the same probe).











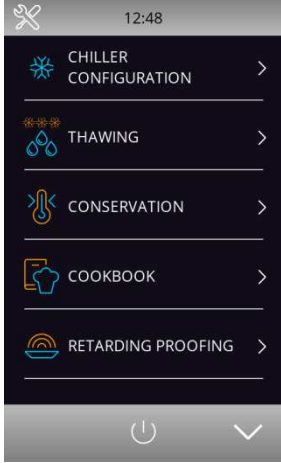
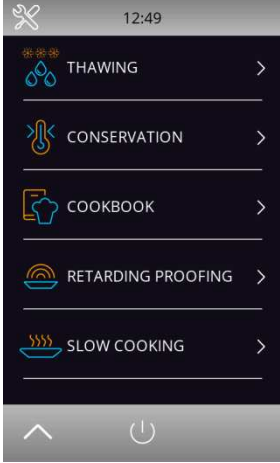



Once the type of probe has been set, parameter P9 sets:

- the number of probes, when P3=2 (multiprobe);
- the number of sensors, when P3=3 (multipoint).

If a multipoint probe is to be used for running temperature controlled blast chilling, blast-freezing and sanitation cycles, the hottest sensor will be used as the reference point. For slow cooking cycles and for heating the probe, the coldest sensor will be used.

6.3 Selecting the operating mode

All the operating functions can be accessed from the Home screen by selecting the specific area. According to the selected machine type (see parameter E13), the Home screen menu will differ as detailed in the following table.

Blast chiller		Multifunction machine	
			
	Makes it possible to select a cabinet pre-cooling cycle, see chapter 10.		
	Enables the blast chilling mode in which it is possible to select/set a standard blast chilling/blast-freezing cycle, a multineedle probe or multi-timer cycle, see chapter 7.		
	Enables special cycles in which it is possible to select one of the special cycles available according to the configuration of the machine, see chapter 8.		⚠ <u>In the Blast Chilling mode, these functions can be accessed through the area</u>
⚠ <u>In the Blast Chilling mode, these functions can be accessed through the area</u>	Makes it possible to select a retarding proofing cycle, detailing date and time for cycle end; see section 8.8.		
	Makes it possible to select a slow cooking cycle; see section 8.9.		
	Makes it possible to select a thawing cycle; see section 8.2.		
	Makes it possible to select a conservation cycle; see section 8.10		
	Makes it possible to access the recipe book mode, where pre-saved recipes are available for selection; see chapter 9.		
	This area is displayed if an alarm is in progress.		
	Pressing this area enables the historical data stored during operation to be seen. See sections 7.6.2 and 12.2.		

7 BLAST CHILLING



Press on this area to open the screen shown below.



Now one of the areas shown can be selected: blast chilling, blast-freezing, continuous cycle and customized cycle, details below.

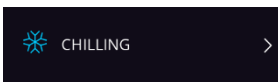

Enables selection of a standard blast chilling cycle, uploading the relevant pre-settings. On the same screen it is possible to select hard mode when blast chilling consists of two phases with different set points. When blast chilling is complete the corresponding conservation phase is run, with the set points established by the blast chilling mode selected. See sections 7.1 and 7.2

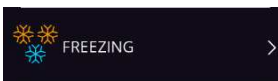

Enables selection of a standard blast-freezing cycle, uploading the relevant pre-settings. On the same screen it is possible to select soft mode when blast-freezing consists of two phases with different set points. When blast-freezing is complete the corresponding conservation phase is run, with the set points established for the blast-freezing mode selected. See sections 7.1 and 7.2.

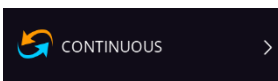

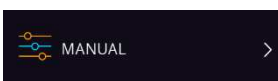

Enables selection of a continuous blast chilling/blast-freezing cycle, where it is possible to set multiple operating timers. For more detail see section 7.3.







Press on this area to start up the procedure for setting a customized cycle. This cycle makes it possible to set up to four phases. Once the phases are set they can be started up or the program set can be saved in the recipe book. See section 7.4

7.1 Blast chilling/blast-freezing and conservation

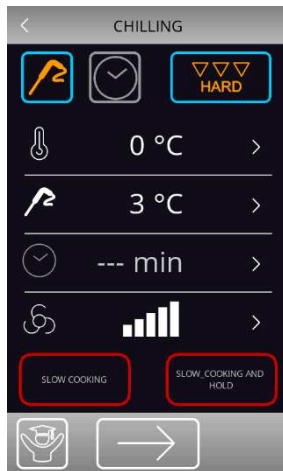



Pressing on one of these areas enables a blast chilling or blast-freezing cycle to be set. The following screen opens and the  key is activated. If the needle probe is being used and there is no error, the cycle always defaults to temperature control. To move to a time controlled cycle, press area  which will deactivate the needle probe area and the time controlled area will be activated.



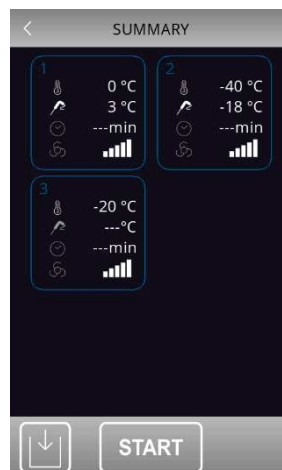

The cycle selected will use the preloaded settings for that cycle, but pressing area  makes it possible to change the main settings, within the permitted range, which are shown on the display. To change all the various set points for the phases of the selected cycle, expert mode can be enabled by pressing area . Once all the settings have been done, press area  to terminate the phase. The screen summarising all the setting data for the cycle will appear, as shown below.



Press area  to save the program just set, or press area  to start up the cycle.

Se il ciclo è a temperatura, viene eseguito il test per verificare il corretto inserimento della sonda spillone nell'alimento da abbattere. Se il test non viene superato, il ciclo si commuta automaticamente sulla modalità a tempo: il buzzer emette un suono e sul display viene visualizzato il simbolo di allarme in corso. Per maggiori dettagli sulla modalità di esecuzione del test, vedere il paragrafo 7.6.1.

While the cycle is in progress, the display will show the main set points. The graphic charting the temperature will be displayed pressing the  key. The key will be displayed after 5 minutes from the cycle start and updates will take place with a one-minute frequency. The cycle can be stopped at any time by pressing the  key.

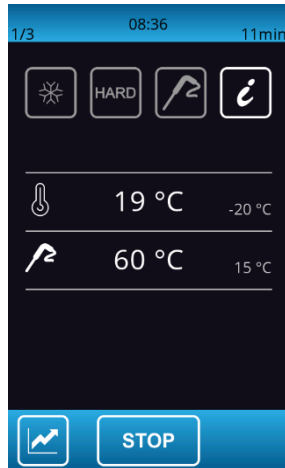

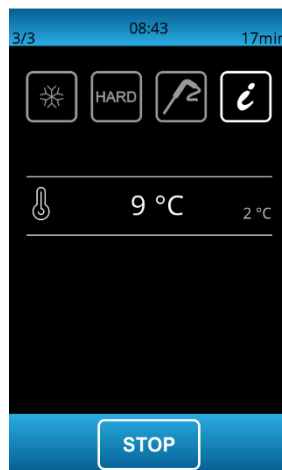

On completion of the blast chilling/blast-freezing cycle, when the needle probe has reached the right temperature or the time period is finished, the buzzer sounds and the conservation phase begins.



The conservation phase is not timed and is only terminated when the  key is pressed.

7.1.1 Combined cycle with slow cooking

When setting a manual blast chilling/freezing cycle, if available in the machine configuration a slow cooking cycle can be added after a blast chilling/freezing. In the lower part of the screen, two dedicated areas make it possible to add a slow cooking phase  or a slow cooking + holding phase. .





For slow cooking or slow cooking + holding the pre-settings are those of the standard cycles.

When setting a manual cycle, the values of each phase can be edited any time.

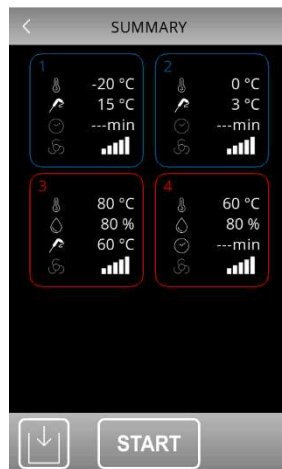
Below is an example for setting a hard blast chilling+ slow cooking + holding.



7.2 Hard blast chilling/soft blast-freezing and conservation

It is possible to select a hard blast chilling/soft blast-freezing cycle on the blast chilling/blast-freezing settings screen by pressing area  or . Before selecting this mode, make sure the type of cycle (temperature or time controlled) has been set.

This cycle consists of two blast chilling phases at different set points, followed by a conservation phase.

- The first phase, known as hard for blast chilling and soft for blast-freezing, has set points established by the relevant parameters and these cannot be modified;
- The set points for the second blast chilling/blast-freezing phase can be modified;
- The set points for the third conservation phase can be modified.

Once the phase is complete, the controller moves on automatically to the next one. The end of the first two phases is signalled by the buzzer sounding.

It is also possible to select the time controlled mode for this cycle, in which case the controller moves on to the next phase when the set time has elapsed.

7.3 Continuous cycle

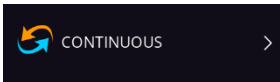

Pressing on this area enables selection of a continuous cycle and it can be run in multineedle probe mode if a temperature controlled cycle has been selected, or in multi-timer mode if a time controlled cycle has been selected. If only a single needle probe has been selected, only the multi-timer mode can be used.

Once the cycle has been selected, a screen opens up on which the cabinet temperature values and fan speed can be set, as well as the product temperature values (in the multineedle probe cycle).

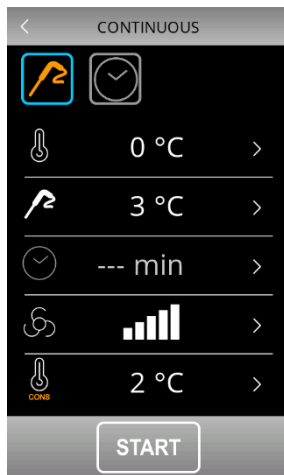

Continuous cycle - needle probe

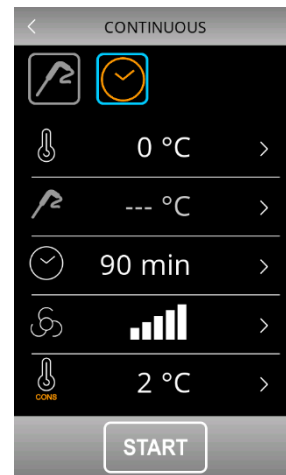

Continuous cycle - time control

Press the **START** key to start up the cycle and this will only finish when all the needle probes have reached the set temperature or all the timers have elapsed, after which the controller moves on automatically to the conservation phase.

7.3.1 Multineedle probe mode

The continuous cycle using multineedle probes can be run provided the parameter for the type of needle probe has been correctly set (P3=2). The controller can manage up to three needle probes, using parameter P9 to set these up. While the cycle is in progress, each time the door is opened and closed the controller checks that the various needle probes have been properly inserted and the cycle is only terminated when all the probes inserted have reached the desired temperature.

When each needle probe has reached the set temperature, the buzzer sounds and the display indicates this, showing the temperature of the probe in question in green. The diagram below shows an example of the display when only one probe has reached the set temperature.

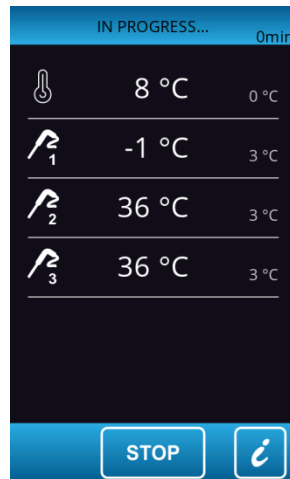

7.3.2 Multi-timer mode

The time controlled cycle makes it possible to set up to four timers.

The cycle starts up activating only the first timer with its pre-set values. The other timers and their pre-set values can be enabled by pressing the pencil icon and setting a time once the cycle is underway.

When the time period is set and the timer setting confirmed, the timer count starts up immediately. Each timer operates independently and on completion of the period it can be reset, starting the timer count up again.

The cycle only terminates when all the set timers have elapsed. When the timer count is complete the buzzer sounds and the display shows in green the value "0 min" for the relevant timer.

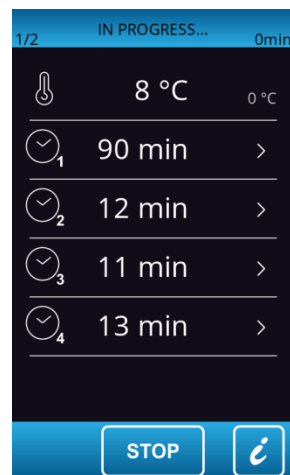

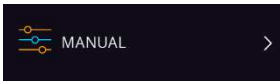

7.4 Customized cycle

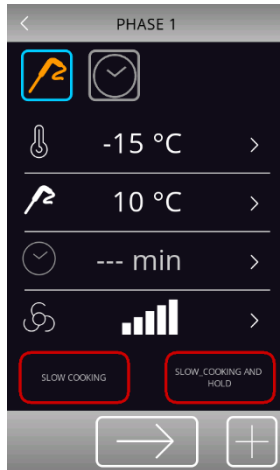

The customized mode makes it possible to set up a cycle consisting of a maximum of 4 phases (3 blast chilling and 1 conservation) and these can be temperature or time controlled or a mixture of both.





The customized cycle starts up and activates the first phase, which by default is a needle probe phase. It is possible to change the probe phase to a time controlled phase and to set the relative set points.

To add any more phases press area , while to eliminate any phase previously set in the program, press area . It is possible to move between the various phases using the arrows at the top of the screen.

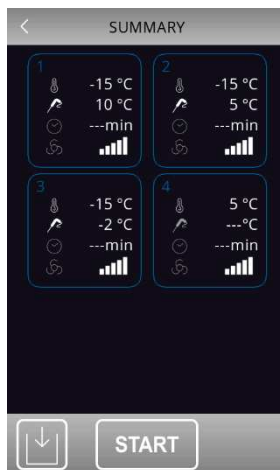
Once the desired phases have been selected and set up, press area  to confirm that the settings are complete and a summary screen will be displayed.





Press area  to start up the cycle or area  to save it in the recipe book.

7.5 Setting the set points

7.5.1 Setting the cabinet temperature set point

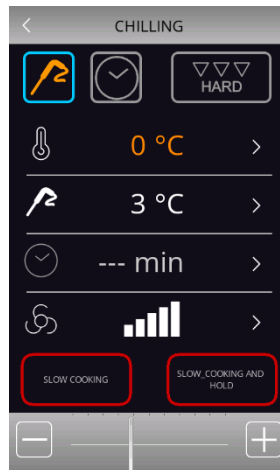
When selecting a continuous or customized blast chilling or blast-freezing cycle, the pre-set cabinet temperature, product temperature, time and fan speed values when the parameters were set are loaded. These can be modified by the user within the permitted range for the parameters. To make a modification press the  key next to the value to be edited. The screen shown below will appear and the editable value will become orange.



Set the desired value using the  key. Once set-up is complete press the  next to the edited value and return to the previous screen.

7.5.2 Setting the product temperature set point

Proceed as described for the cabinet set point, after pressing area  for the product temperature (or the temperature indicated by the needle probe).

7.5.3 Setting the cycle duration

Proceed as described for the cabinet set point, after pressing area  for the cycle duration.

7.5.4 Setting the fan speed

Proceed as described for the cabinet set point, after pressing area  for the fan speed.

The minimum fan speed value that can be set for all cycles (except for slow cooking) is given by parameter F53.

The minimum fan speed value that can be set for slow cooking is given by parameter F54.

7.6 Running the cycle

Pressing the **START** key starts up the cycle as it has been set. If it is a temperature controlled cycle, the blast chilling/blast-freezing phases terminate when the needle probe, or probes, reach the set temperature. If it is a time controlled cycle, the blast chilling/blast-freezing phases terminate when the set time period, or periods, have elapsed. While the cycle is in progress the screen below will be shown.

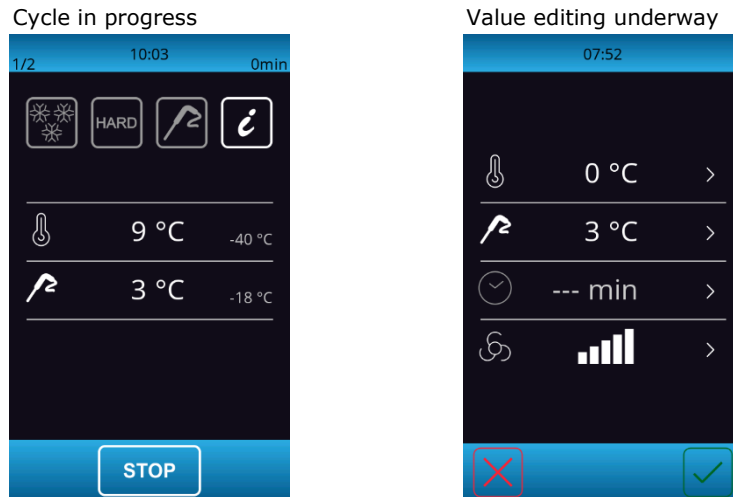

The screen shows a summary of the features of the cycle in progress. Pressing the temperature area the display switches to the screen where the values of the ongoing cycle can be edited.

Press area  to see the probe values, input and output status and any alarms underway.

Press area , which is only active when an alarm is underway, to see the type of alarm in progress.

7.6.1 Needle probe insertion test

If the needle probe is enabled or if parameter P3 is set to a value other than 0, temperature controlled cycles are preceded by a two-phase test to check that the needle probe is correctly inserted. If the needle probe is not enabled or if parameter P3 is set at 0, only time controlled cycles can be selected.

The test consists of two phases, the second only carried out if the first was not successfully completed. Phase one is successfully completed if the gap between the "temperature detected by the needle probe" and the "cabinet temperature" is greater than the value set by parameter r17 in at least three out of five checks, these checks being performed at ten-second intervals. The second phase is successfully completed if the gap between the "temperature detected by the needle probe" and the "cabinet temperature" is greater than 1°C/1°F, as compared to the check previously carried out, in at least six out of eight checks, these checks being performed at intervals corresponding to 1/8 of the time set by parameter r18.

If a multineedle probe is being used, the test is performed for each probe.

If a multipoint probe is being used, when the test is concluded with a positive result for at least one of the sensors, the device will function as follows.

- The sensor showing the lowest temperature is then used as the point of reference for heating the needle probe.

- The sensor showing the highest temperature is then used as the reference point for the end of the temperature controlled cycles.
- Any sensors for which the test is not completed with a successful outcome are not subsequently used.

If the test fails to record a positive outcome, that is to say the needle probe is not inserted, the buzzer sounds and the cycle automatically changes to time-controlled or keeps on as a temperature-based cycle, depending on how parameter E14 is set.

7.6.2 Recording historical data

While a cycle is in progress records are kept of the temperature values of any probes enabled, output activations, input status, defrosting cycles carried out and any alarms.

The type of data to be recorded can be set using the menu accessible from the service area, see section 12.1.

These data are available for subsequent download to a USB device, see section 13.4.

7.6.3 Cycle end

If the temperature controlled blast chilling/blast-freezing cycle is successfully completed, in which the centre of the product reaches the required temperature in the allotted time, the device moves on automatically to the conservation phase, with the following screen appearing.

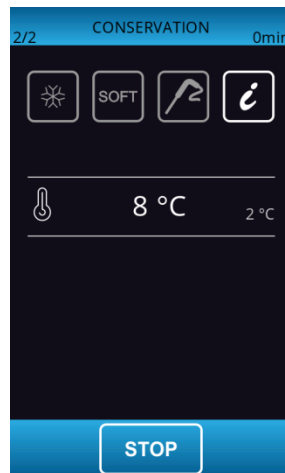

If the temperature controlled cycle is not completed in the allotted time, this problem will be signalled by the appearance of the alarm icon, but the blast chilling cycle will still continue.

In temperature controlled cycles, pressing the **STOP** key will bring up the screen granting access to the following functions.

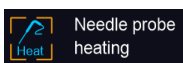

heat needle probe to remove it from the product;



record the cycle just performed in the memory.



At the end of a time controlled cycle, the initial screen for the blast chilling/blast-freezing modes will appear.

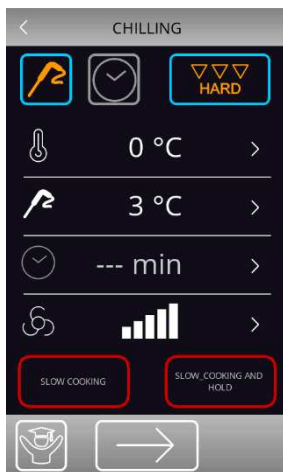

8 SPECIAL CYCLES



Press this area on the Home page to open the screen shown below.



This screen grants access to further functions, some always present, others that can be activated by setting the parameter. If the function is not available, the area relating to that function and enabling it to be selected will not be shown.

The functions available are listed below



Pressing this area enables selection of a fish sanitation cycle (a function always shown); see section **Errore. L'origine riferimento non è stata trovata..**



Pressing this area enables selection of a thawing cycle (a function always shown); see section **Errore. L'origine riferimento non è stata trovata..**



Pressing this area enables selection of a manual defrost cycle (a function always shown); see section 8.3.

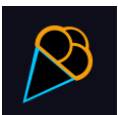

Pressing this area enables selection of an ice cream hardening cycle (a function always shown); see section 8.4.



Pressing this area enables selection of a sterilisation cycle (a function activated by parameter); see section **Errore. L'origine riferimento non è stata trovata..**

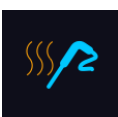

Pressing this area enables selection of a needle probe heating cycle (a function activated by parameter if at least one needle probe is being used); see section 8.6.



Pressing this area enables selection of a drying cycle (a function activated with the door closed); see section 8.7.



Pressing this area enables selection of a proofing cycle (a function activated by parameter); see section **Errore. L'origine riferimento non è stata trovata..**



Pressing this area enables selection of a slow cooking cycle (a function activated by parameter); see section 0

The retarding proofing and slow cooking functions are available on condition that the expansion module is in use and parameter E12 is properly set.

8.1 Fish sanitation



Pressing this area enables selection of a fish sanitation cycle.

This special cycle consists of the following phases:

- blast chilling with the cabinet set point set by parameter r19 and with the product temperature set point set by parameter r20;
- holding for the time period set by parameter r21 and the cabinet set point given by r20;
- conservation with the cabinet set point given by r22.



The arrows at the top make it possible to move between the various sanitation phases to see/modify the set points.

After the function is selected, the screen with the pre-settings will be shown, that can be modified.

Pressing the **START** key starts up the sanitation.

While a sanitation cycle is in progress the device will show the temperature to end blast chilling, the working set point during blast chilling and the duration of the holding phase.

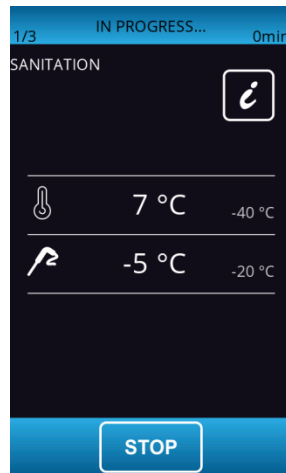

The sanitation cycle starts with the blast chilling phase. When the temperature recorded by the needle probe reaches the temperature to end blast chilling, the device will move on automatically to holding.

The temperature to end blast chilling (set by r20) is also the working set point during holding.

When the holding period has elapsed, the device will move on automatically to conservation.

The probe insertion test is always carried out at the beginning of the cycle: if the test is not completed, the buzzer sounds and the cycle is interrupted.

During blast chilling the device shows the temperature recorded by the needle probe, the cabinet temperature and the time elapsed since the start of the blast chilling process.

The cycle may be interrupted early by pressing the **STOP** key.

8.2 Thawing



Pressing this area enables selection of a thawing cycle, managed according to the load of product to be thawed, in compliance with the maximum quantity stated by the manufacturer.

Where possible, a slow-cooking phase or a slow cooking + holding phase can be combined with thawing.

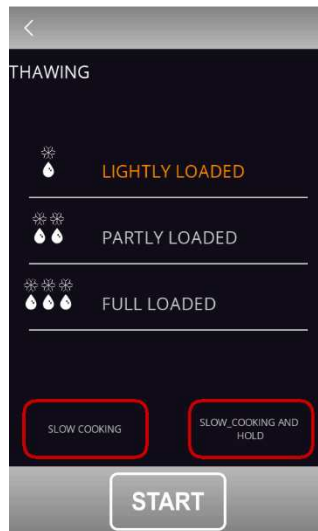

To make it easy, the quantity of product to be selected is divided into three load bands for each of which the controller will load three different sets of parameters, according to the following framework.

Load band	Initial cabinet set point	Final cabinet set point	Cycle duration
Lightly loaded	r25	r28	r32
Partly loaded	r26	r29	r33
Full loaded	r27	r30	r34

These three parameters will be used to control the working cabinet set points and the duration of the thawing cycle, equally divided into five phases following on from each other as shown.

- Phase 1 working set point = initial set point
- Phase 2 working set point = phase 1 set point - $[(\text{initial set point} - \text{final set point}) / 4]$
- Phase 3 working set point = phase 2 set point - $[(\text{initial set point} - \text{final set point}) / 4]$
- Phase 4 working set point = phase 3 set point - $[(\text{initial set point} - \text{final set point}) / 4]$
- Phase 5 working set point = final set point

set 1 = initial set point
 set 2 = final set point

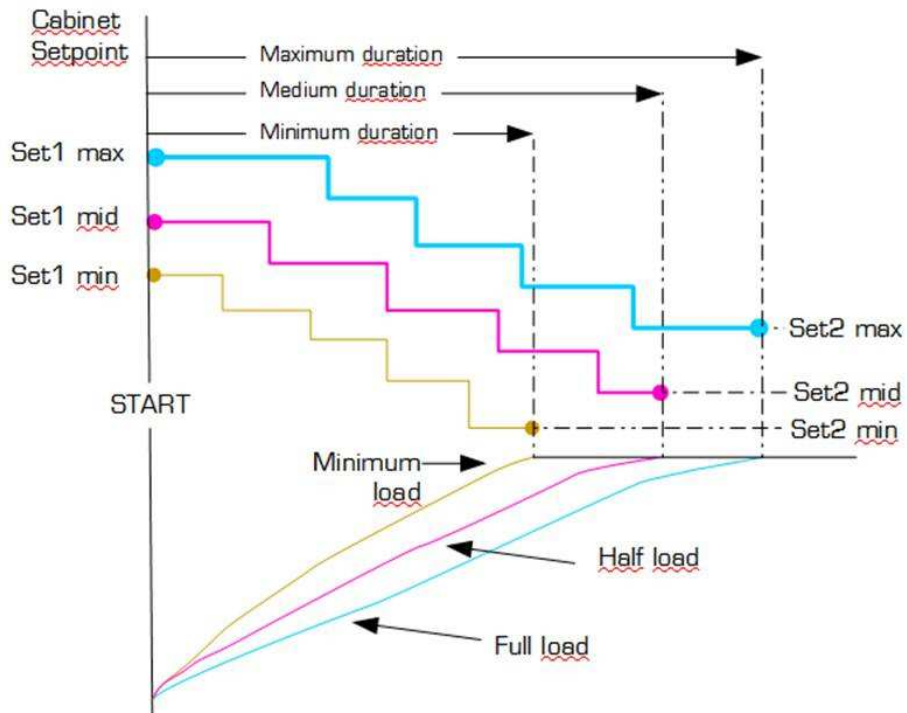

Five parameters are used to manage the ventilation, one for each phase, setting the fan speed independently of the load. These parameters are: F29, F30, F31, F32, F33.

At the end of the thawing cycle the buzzer sounds, after which the machine moves on to a conservation phase, its set point set by parameter r31 for an indefinite period. The fans will work at the speed set by parameter F34.

It is not possible to run defrosting cycles during thawing, while during the conservation phase an automatic defrost can be run at intervals set by parameter.

If the door is opened, the heater will be stopped no matter what the parameter value is. The screen shot below shows a thawing cycle in progress.

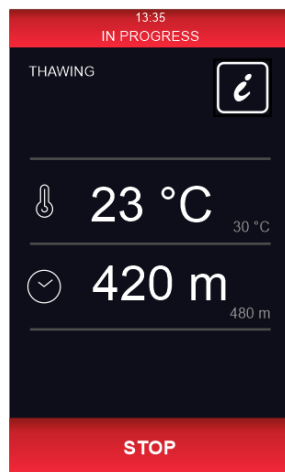

8.3 Defrosting



Pressing this area enables selection of a manual defrosting cycle, which is started up by pressing area **START**. When the cycle starts up the following page is displayed.

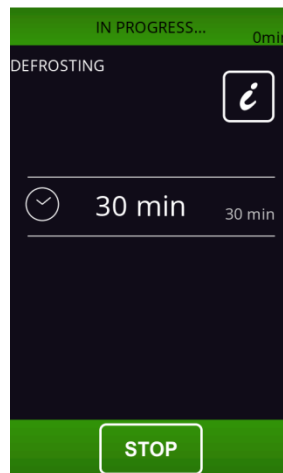

Defrosting can also be done automatically at time intervals set by parameter d0, provided this value is not set at 0. Regardless of how have been started up, defrosting cycles are managed by the following parameters.

- d0 Interval between two consecutive defrosts
- d1 Type of defrost
- d2 Evaporator temperature to end defrost (can be set if P4 is set to 1)
- d3 Defrost duration
- d4 Defrost start-up at the beginning of a blast chilling/blast-freezing cycle
- d5 Defrost start-up delay from the start of conservation after blast chilling/blast-freezing
- d7 Drip duration
- d15 Minimum compressor switch-on duration for starting hot gas defrost
- d16 Pre-drip duration (can be set if hot gas defrost is selected)

The type of defrost can be selected by parameter d1. There are four ways of performing a defrost cycle.

- d1=0 Electric defrost
- d1=1 Hot gas defrost
- d1=2 Air defrost
- d1=3 Air defrost with door open

An automatic defrost cycle is activated at the start of a blast chilling/blast-freezing cycle if d4=1. Regardless of the parameter d4 value, automatic defrost is activated with a delay as compared to the beginning of the conservation phase set by parameter d5.

If the evaporator probe is present when a defrost cycle is to be activated, this only starts if the temperature indicated by the evaporator probe is lower than the value of parameter d2.

Defrosting finishes when the evaporator temperature is above the value of parameter d2 or if the temperature has not been reached within the required time set by parameter d3. In this case there is an alarm signal.

8.4 Ice cream hardening



Pressing this area enables selection of an ice cream hardening cycle.



This is a time controlled blast-freezing cycle with the set point provided by parameter r8 and the duration by parameter r24. At the end of the time set by r24, there is no move to a conservation phase, the hardening cycle continues until the **STOP** key is pressed.

If the door is opened the time count stops and restarts when the door is closed.

8.5 Cabinet sterilisation



Pressing this area enables selection of a sterilisation cycle.



The cabinet door must be closed to start up a sterilisation cycle.

Pressing the **START** key starts up the sterilisation cycle.

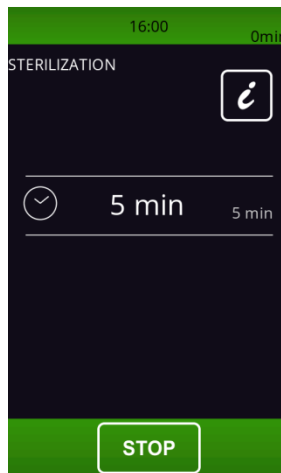

Sterilisation ends when the time set by parameter u6 has elapsed, after the **STOP** key has been pressed or if the door is opened. During sterilisation the cabinet sterilisation relay is active. If parameter u11 is set to 1, the evaporator fans are also active. If the fans are run at variable speeds, there will be 100% ventilation during sterilisation. The display will show the count-down for the remaining time. At the end of the cycle the buzzer sounds and the screen returns to the Home screen.

8.6 Heating the needle probe



Pressing this area enables selection of a needle probe, or probes, heating cycle. The cycle can be run only if the door is open.

This cycle can also be run automatically if the **STOP** key is pressed during conservation, following a blast chilling/defrosting cycle.

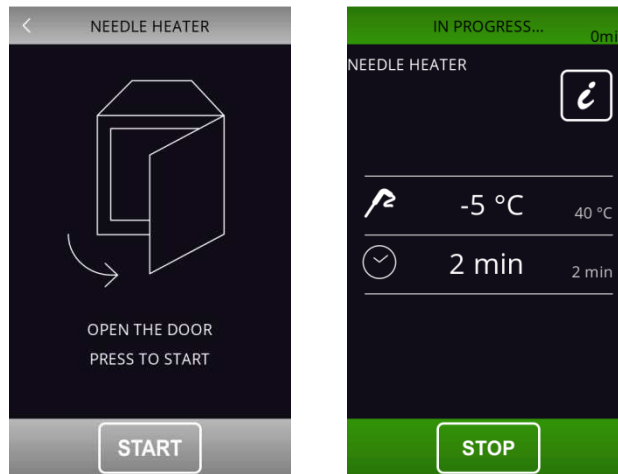

The needle probe heating output is activated at maximum for the time set by parameter u8 or until the temperature indicated by the needle probe has reached that set by parameter u7.

At the end of heating, the buzzer sounds.

Heating can be stopped by pressing the **STOP** key.

8.7 Drying



Pressing this area enables selection of a drying cycle.

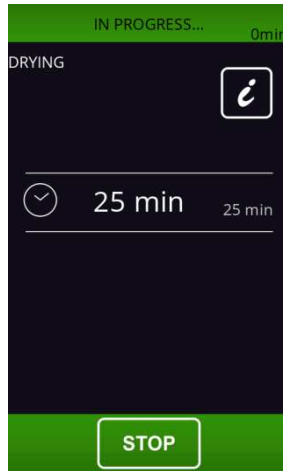

This is a cycle of forced-air ventilation that can be activated with the door closed and for a duration set by parameter u13. If the door is opened during drying this does not affect the cycle.

The cycle stops when the prescribed time has elapsed or when the **STOP** key is pressed.

8.8 Retarding proofing



Pressing this area enables selection of a proofing cycle. This function can only be enabled if an expansion has been set (parameter E12).

8.8.1 Description of retarding proofing

The controller provides complete control for retarding-proofing cabinets for bread or pastry by managing the complete dough retarding-proofing cycle automatically.

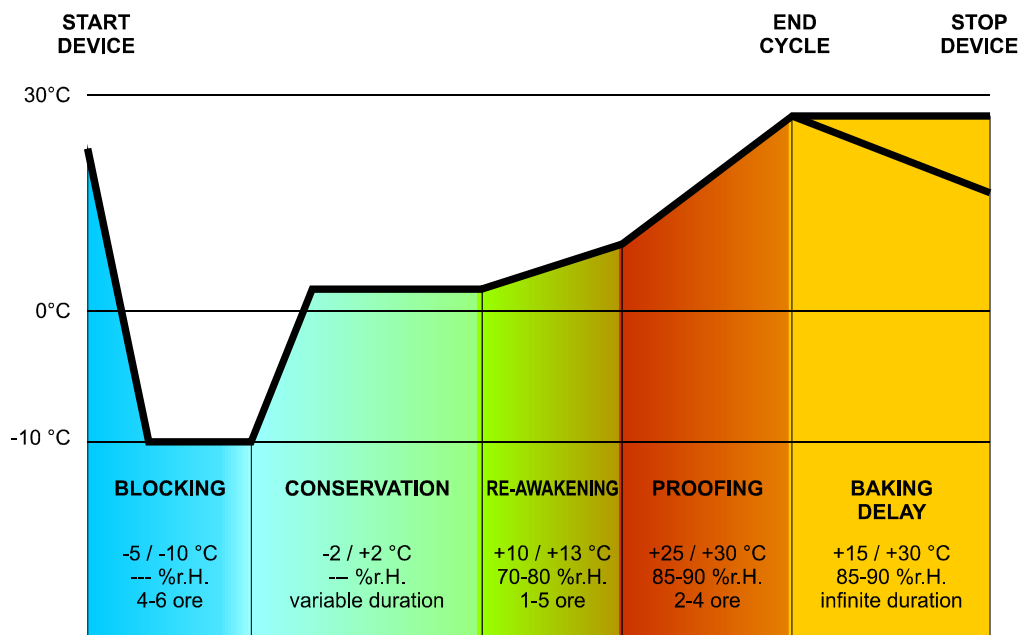

A proofing cycle consists of 5 phases with different temperatures, relative humidity, fan speeds and durations, one following on from the other, as in the sequence described below.

8.8.1.1 BLOCKING phase

Temperature regulation is active and has a neutral zone adjustment, the temperature setpoint, the fan speed and duration in hours and minutes for the phase are set by the end-user. This phase does not include humidity control.

8.8.1.2 CONSERVATION phase

Temperature regulation is active and has a neutral zone adjustment, the temperature setpoint and the fan speed are set by the end-user. This phase does not include humidity control.

Moving from the blocking setpoint (previous phase) to the conservation setpoint can be gradual, with the incremental percentages set while the parameters are being set.

The duration of this phase is calculated automatically by the controller on the basis of the duration of the blocking, re-awakening and proofing phases and the day and time for the end of proofing required for the dough.

8.8.1.3 RE-AWAKENING phase

Temperature regulation is active and has a NEUTRAL ZONE adjustment, the working setpoint is set by the end-user. Moving from the conservation setpoint (previous phase) to the re-awakening setpoint can be gradual, with the incremental percentages set while the parameters are being set.

Relative humidity regulation is active and has a NEUTRAL ZONE adjustment, the working setpoint is set by the end-user.

The duration in hours and minutes and the evaporator fan speed are set by the end-user.

8.8.1.4 PROOFING phase

Temperature regulation is active and has a NEUTRAL ZONE adjustment, the working setpoint is set by the end-user. Moving from the re-awakening setpoint (previous phase) to the proofing setpoint can be gradual, with the incremental percentages set while the parameters are being set.

Relative humidity regulation is active and has a NEUTRAL ZONE adjustment, the working setpoint is set by the end-user.

The duration in hours and minutes and the evaporator fan speed are set by the end-user.

8.8.1.5 BAKING DELAY phase

The baking delay is always enabled but can be disabled, either when the cycle is being set up or while it is in progress, by the end-user.

Temperature regulation is active and has a NEUTRAL ZONE adjustment, the working setpoint is set by the end-user.

Relative humidity regulation is active and has a NEUTRAL ZONE adjustment, the working setpoint is set by the end-user as is the evaporator fan speed.

Theoretically this phase has an infinite duration as it terminates when the cycle is interrupted by prolonged pressing (for 4 seconds) of the  key.

To make it possible to regulate in these ways, the controller must manage the loads associated with cooling (compressor, evaporator fan, defrost, pump-down solenoid valve), with heating (heating element), with humidification (steam generator, steam injection valve) and with dehumidification (dehumidification by activating the refrigeration plant). The way each function is regulated is described in subsequent sections.

8.8.2 Setting up a retarding proofing cycle

8.8.2.1 Starting and stopping a cycle

Press the  key to access to the following screen displaying all the phases making up a RETARDING-PROOFING cycle: blocking, conservation, re-awakening, proofing and baking delay



The cycle starts up when the **START** area is pressed and it terminates automatically at the end of phase 4 and according to the date and time set for it to end, at which time a buzzer sounds.

If the end-date and time are later than the sum of all the timings for each phase, the controller will automatically increase the conservation time (phase 2) to fill the time gap.

The cycle can be interrupted manually during any phase by holding the **STOP** key down for 4 seconds.

N.B. Phase 5 (baking delay) is optional and does not require a duration to be set and therefore, if enabled, it can only be terminated manually by pressing the **STOP** key.

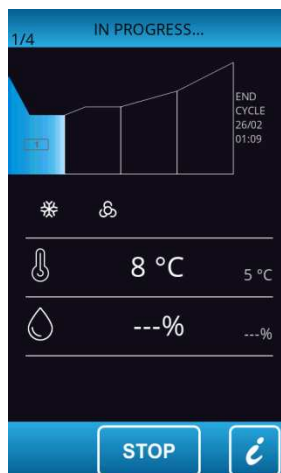

8.8.2.2 Making changes to cycle phases

Before starting up a cycle, the setpoint setting menu can be accessed for each of the retarding-proofing phases and pressing the corresponding coloured area will enable changes to be made to the phase in question.

By default the controller always loads the pre-set values for the various phases as shown in the table below (these can be personalised via the manufacturer’s parameters). The settings for the cycle can be modified before it is started up

using the special menus and once the **START** key has been pressed, the proofing cycle starts up. It is not possible to modify the set points while the cycle is in progress. If a phase is set at 0, it will not be run. In the blast chilling phase the cabinet humidity control can be omitted using parameter rU4, but this must be set in the other phases. The conservation phase may be omitted by setting the time to "---".

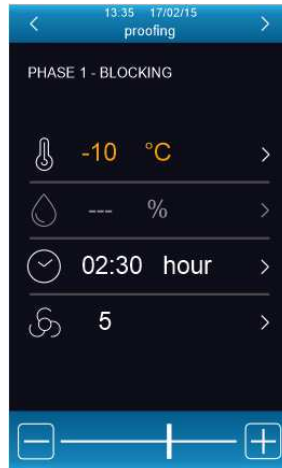

Blast chilling	Cabinet setting (rC3)	5°C
	Humidity setting (rU5, only if rU4=1)	---
	Duration setting (rH7)	120 min
	Ventilation setting (F42)	5
Re-awakening	Cabinet setting (rH3)	20°C
	Humidity setting (rU6)	60 %rH
	Duration setting (rH8)	240 min
	Ventilation setting (F43)	5
Proofing	Cabinet setting (rH4)	30°C
	Humidity setting (rU7)	80 %rH
	Duration setting (rH9)	180 min
	Ventilation (F44)	5
Conservation	Cabinet setting (rH5)	25°C
	Humidity setting (rU8)	80 %rH
	Enable phase	"Inf" (enabled), "---" (disabled)
	Ventilation setting (F45)	5

8.8.2.3 Making changes to cycle end date and time

The  icon is displayed on the bottom left of the screen showing the date and time set for the end of the cycle, which are calculated automatically by the controller on the basis of the sum of times set for each individual phase (from phase 1 to phase 4).

Pressing the CYCLE END area makes it possible to change the date and time of the cycle end. Make sure to change the time first and then change the date. To confirm the new time and date, go back to the cycle start screen. To restore the previous time and date, press the REFRESH key .

NB: Time and date can be changed provided they are later than the first appropriate value calculated by the controller.

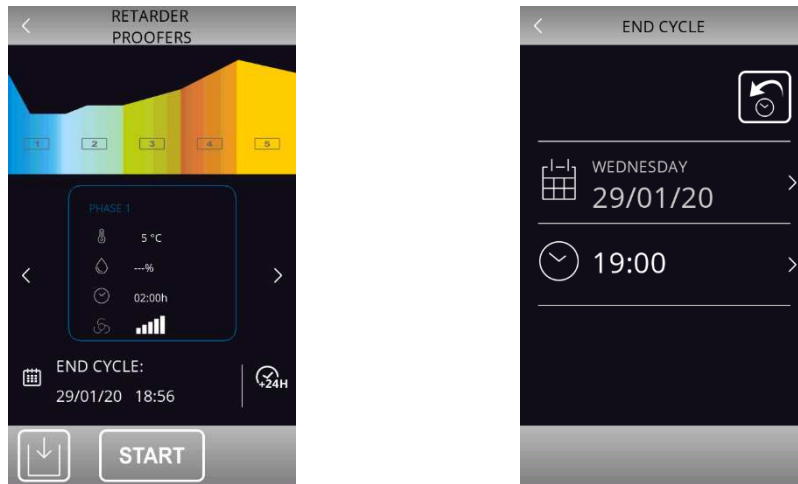

Alternatively, the cycle end date can be postponed using the  quick key.

8.9 Slow cooking



Pressing this area enables selection of a slow cooking cycle, which can consist of two phases. This function can only be enabled if an expansion has been set (see parameter E12).

After selection of the slow cooking function, a screen will appear on which it is possible to view and modify the relevant set points and to decide whether to set up a temperature or time controlled process. It is not possible to modify the set points while the cycle is in progress.

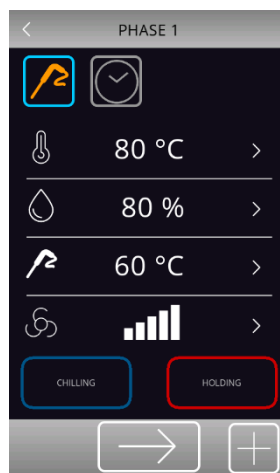

The slow cooking pre-settings use the following parameters:

- rH10 cabinet set point
- rH11 product temperature set point
- rH12 cycle duration
- rU9 % humidity

F40 fan speed

Two areas at the bottom of the screen make it possible to add a subsequent blast chilling/blast-freezing phase **CHILLING** and a product holding/conservation phase **HOLDING**.

For blast chilling or blast-freezing, the pre-settings are those for the cycle, whereas the following parameters are used to set up a holding or conservation phase:

- rH13 cabinet set point for holding phase
- rU10 % humidity in holding
- F41 fan speed

If a holding phase has been enabled following a slow cooking cycle, this will be activated at the set temperature and humidity and it will have an indefinite duration. If blast chilling or blast-freezing has been enabled, this will be performed according to the procedures for the cycle in question (blast chilling/blast-freezing and moving on automatically to conservation).

Slow cooking + holding

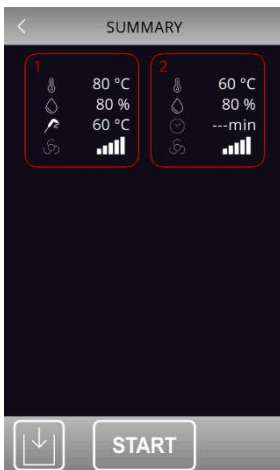

Slow cooking +blast-chilling + holding

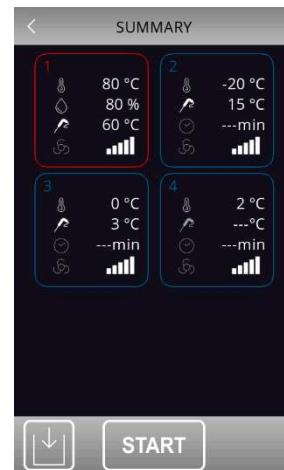

8.10 Conservation



Press this area to select a conservation in cooling, heating or neutral zone mode.

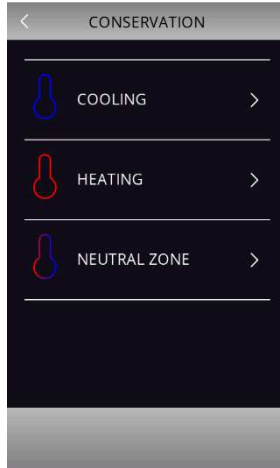

The presettings of the cooling cycle are those of the blast-chilling, while the presettings of heating and neutral zone cycles are those of slow cooking. Before starting the cycle, all the values of a conservation cycle can be modified.

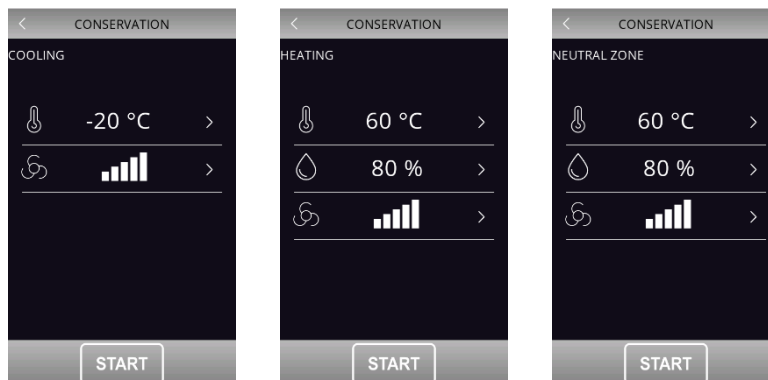

The cycle starts when the **START** area is pressed and remains active until the **STOP** area is pressed.

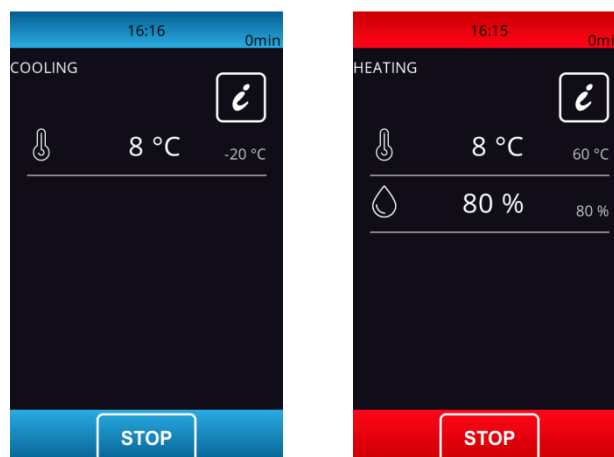

9 RECIPE BOOK

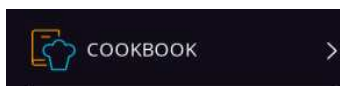

The controller has two types of recipe book: "Cookbook" and "My Cookbook".

9.1 "COOKBOOK" recipe book

It is an area mainly dedicated to OEM, who need full autonomy when personalizing the recipe books for their customers. Up to 72 "OEM" recipes, divided into 8 categories, can be saved. Each category can include a maximum of 9 recipes complete with RECIPE PICTURE and RECIPE NAME that can be translated into any language desired. If a category does not include any recipes, that category will not be displayed.

Parameter E15 defines whether OEM recipes can be overwritten by the user.

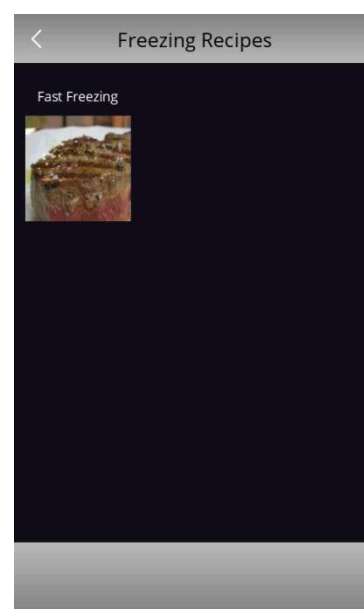
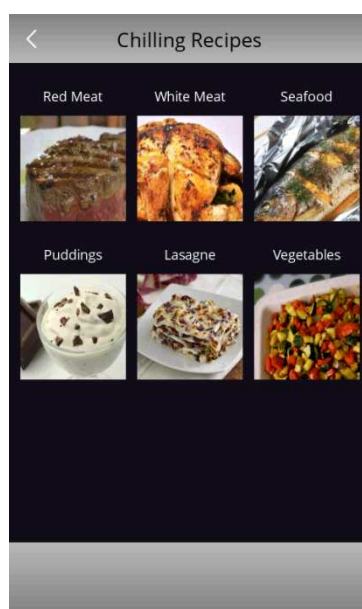
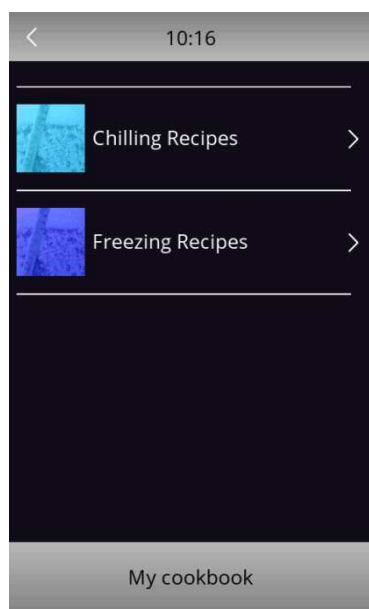

An easy procedure makes it possible to save (but not to export) OEM recipes via USB. In this event it is necessary to proceed with an update following the procedure below:

- From the stand-by screen select the CONFIGURATION  icon
- Select SERVICE
- Select RESTORE OEM RECIPES
- Input password 99
- Confirm and wait until the device re-starts automatically.

To reset to factory defaults, the procedure to follow is the same as indicated above.

For more details on the "OEM" recipe saving procedure, please contact the EVCO sales network.

9.2 "MY COOKBOOK" recipe book

It is an area dedicated to the final customer. It is possible to save up to 40 recipes using the Western alphabet and without translation. This type of recipes can be saved only from the controller, but they can be exported to another controller via USB flash drive. For more details on the " MY COOKBOK" recipe saving procedure, see following sections.

9.2.1 Saving "MY COOKBOOK" recipes

It is possible to save both time and temperature controlled cycles. In the latter case the time required to reach the core temperature is saved.

Recipes can be saved in the following ways.

- During conservation after a customized blast chilling/blast-freezing cycle. When the **STOP** key is pressed the device will offer to save the recipe used;
- save a recipe before starting the cycle;
- Select a recipe already present, modify it and save it.

Below is an example showing how to save a recipe before starting the cycle.



After setting the cycle as desired, go to the "Cycle summary" page.

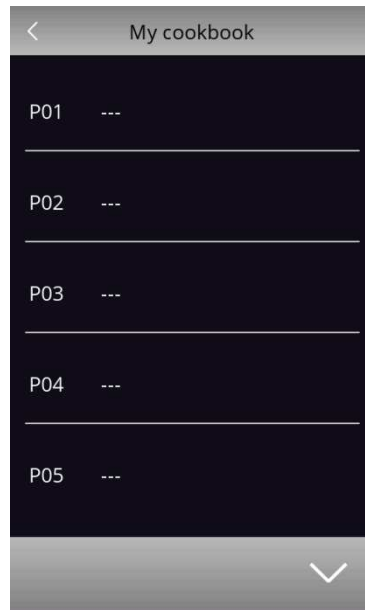

Before pressing the **START** key for the cycle start, save the recipe as follows:

- Press the  key to access the "MY COOKBOOK" page displaying a list with available positions (indicated with "---") and previously saved recipes, if present;





- Scroll the page and select the desired position where to save a new recipe or overwrite an existing one;
- Press  to confirm : the alphabetic keyboard is now accessible (press  to exit the procedure without saving);
- Type the desired recipe name and press  to confirm.
-







➤

If you wish to change the recipe name, proceed as follows:

- Touch the name of the desired recipe;
- Touch  to confirm you want to overwrite: the alphabetic keyboard is now accessible (press  to exit the procedure without saving);
- Cancel the displayed recipe name and type the new name you wish to save:
- Press  to confirm.

9.2.2 Starting "MY COOKBOOK" recipes

To start a recipe, operate as follows:

- Make sure the device is on and no procedure is underway;.
- Touch the  key
- Enter the  menu and select the desired recipe
- In the "Cycle Summary" page touch the  key to start the recipe
- If you wish to modify the recipe, touch  to access the recipe settings.

9.2.3 Deleting "MY COOKBOOK" recipes

To delete a recipe, operate as follows:

1. From "MY COOKBOOK"list, select the recipe you wish to delete and press .

10 PRE-COOLING



Pressing this area on the Home page enables selection of a pre-cooling cycle. This cycle is similar to a normal blast chilling cycle and it may precede all operating cycles.

Pressing the area in question opens the following screen.



Set the required set point value and press area **START** to start the cabinet pre-cooling cycle. The screen below will be displayed showing the pre-cooling cycle in process.

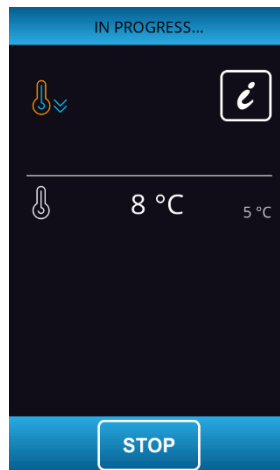

The fan speed is fixed and set by parameter F28.

Press the **STOP** key to stop pre-cooling.

Once the required cabinet set point has been reached, the buzzer sounds and the cycle continues maintaining the cabinet temperature achieved until the **STOP** key is pressed. The controller will automatically return to the Home page.

11 ADJUSTMENTS

11.1 Door frame heating output

This function is only available if one of the relays is configured as door frame heating.

This function is activated automatically when the board is in "on" or "run" mode and the cabinet temperature falls below the value set by parameter u5 minus the fixed hysteresis of 2°C (4°F). The output is deactivated when the temperature rises above the u5 setting.

If there is a cabinet probe error, the heaters are not activated, or if already on, they are deactivated.

11.2 Compressor management

This function is only available if one of the relays is configured as compressor.

The management of the compressor varies according to the cycle activated, as specified below.

➤ **Blast chilling, blast-freezing, pre-cooling, conservation, ice cream hardening, sanitation**

The compressor is activated if the cabinet temperature is above the set point for the type of cycle underway + the hysteresis set by parameter r0. It is deactivated when the temperature falls below the set point for the phase underway.

The compressor must be switched on and off according to the safety periods set by parameters C0, C2 and C3. The drip periods must also be complied with if it is activated after a defrost cycle.

When the compressor is set to switch off, the pump down solenoid valve is first deactivated and once the delay set by parameter u12 has elapsed, the compressor will also switch off.

If there is a fault with the cabinet probe during a conservation cycle, the compressor is activated on a cyclical basis according to the values of parameters C4 and C5 if this is a conservation phase following blast chilling, or according to the values of parameters C4 and C9 for conservation following blast-freezing.

➤ **Defrosting**

During defrosting the compressor status depends on the value of parameter d1. If d1 equals 0, 2 or 3, the compressor is switched off.

If d1 equals 1, the compressor will remain switched on for the entire duration of the defrost cycle and if it is switched off when the defrost cycle is selected, it will be switched on for the period set by parameter d15 before defrosting starts. When defrosting is finished the compressor remains off for the period set by parameter d7.

If parameter d16 is set to a value other than 0, when a hot gas defrost cycle starts the compressor remains off for the pre-drip time set by parameter d16.

➤ **Proofing**

The compressor is managed according to the neutral zone adjustment together with the heaters.

It is activated when the temperature rises above the neutral zone relative threshold (cooling). It remains active until the temperature drops within the neutral zone value.

➤ **Slow cooking**

The compressor is always switched off.

11.3 Gestione secondo compressore

If one of the really outputs is configured as second compressor, compressor 1 and 2 are managed as follows:

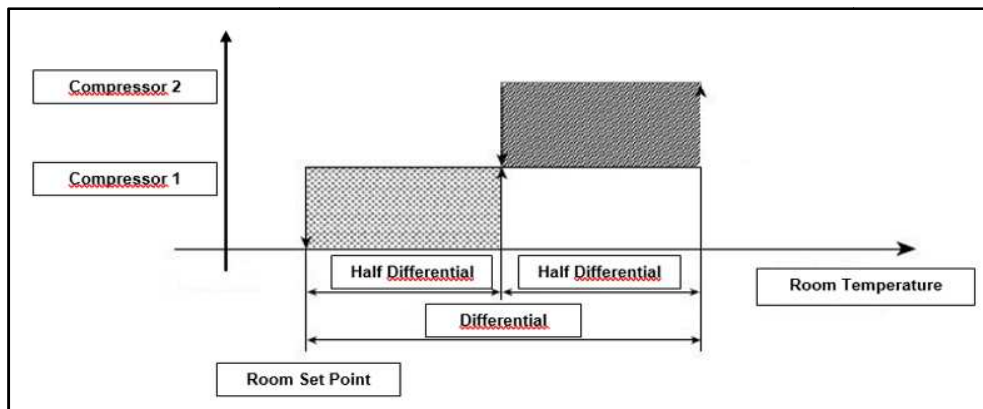

When regulating with 2 compressors, the differential set by parameter $r0$ will be halved: that means that the differential for each compressor is " $r0/2$ ".

When regulation requires the activation of both compressors, the second compressor will be activated with a delay set by parameter $C10$.

11.4 Pump down solenoid valve management

This function is only available if one of the relays is configured as pump down

The pump down solenoid valve is activated in parallel with the compressor.

When the compressor is set to switch off, the pump down solenoid valve is deactivated first and after the number of seconds set by the $u12$ parameter, the compressor is deactivated. This function is only available if parameter $u2=0$.

11.5 Evaporator fan management

The evaporator fan is managed in a modulating mode with the PWM analogue output (to be combined with the EVDFAN1 cutting-phase module) or in an On-Off mode if one of the relays is configured as evaporator fan. The two outputs (PWM or relay) work independently one of another.

If the evaporator fan is managed through a PWM analogue output, the fan speed can be set for each phase. When the fan is switched on, the controller will manage a speed ($F21$) and a start-up time ($F22$). After $F22$ time elapses, the fan will modulate based on the speed set for the ongoing phase within the range set by parameters $F19$ and $F20$, which determine the fan minimum and maximum speed respectively.

Calibration procedure for an evaporator fan managed by the cutting-phase module

In order to make the cutting-phase adjustment suitable to all 230 VAC single-phase motors, it is recommended to perform a manual calibration of the evaporator fan.

1. Set $F19$ to 0% and $F20$ to 100%
2. Perform a manual cycle and, while modulating the fan speed, check the minimum percentage below which the fan stops and the maximum percentage above which the fan runs at the maximum speed.

3. The values obtained this way shall be set for F19 and F20 respectively..

The evaporator fan management differs according to the cycle in use, as specified below. The way the evaporator fan is managed changes depending on the presence of the evaporator probe, which is enabled setting parameter P4 to 1.

➤ **Blast chilling, blast-freezing, conservation, ice cream hardening, customized and continuous cycles, pre-cooling**

The fans are always switched on and are only switched off if the cabinet temperature is above the value of parameter F17 and/or if the evaporator probe temperature is above the value of parameter F1. They are only switched on again if the cabinet temperature falls below the F17-F8 value and that of the evaporator probe falls below F1-F8.

➤ **Conservation**

During conservation, the fans are managed according to parameter F49. If set to 0 (default), the fans will work in parallel to the compressor, if set to 1, the fans will always be active.

➤ **Sanitation (blast chilling and holding)**

The fans are always switched on and are only switched off if the cabinet temperature is above the parameter F17 value and/or the evaporator probe temperature is above the parameter F1 value. They are only switched on again if the cabinet temperature falls below the F17-F8 value and that of the evaporator probe falls below F1-F8.

➤ **Sanitation (conservation)**

The fans are always managed in parallel with the compressor.

➤ **Thawing**

The fans are always active.

➤ **Defrosting**

During defrosting the evaporator fans are switched off if the parameter d1 value is set to 0 or 1. They are switched on if d1 is set to 2 or if the door is open with d1 set at 3.

At the end of the defrosting cycle, the fans remain off for the time set by parameter F3, once the drip time set by parameter d16 has elapsed.

➤ **Proofing (blast chilling)**

The fans are always switched on and are only switched off if the cabinet temperature is above the parameter F17 value and/or the evaporator probe temperature is above the parameter F1 value. They are only switched on again if the cabinet temperature falls below the F17-F8 value and that of the evaporator probe falls below F1-F8.

➤ **Proofing (re-awakening, proofing, conservation)**

The fans are always active.

➤ **Slow cooking and holding**

During slow cooking, the fans will be managed according to parameter F50. If the parameter is set to 0 (default), they will always be active. If set to 1, they will be active when heating elements are ON, while they will be switched on the basis of ON-OFF cycles (parameters F51 and F52) when the heating elements are OFF.

11.6 Condenser fan management

This function is only available if one of the relays is configured as condenser fan.

The management mode of condenser fans varies according to whether the condenser probe is present, which can be enabled by setting parameter P5 to 1. The condenser fan management varies according to the following specific cases.

➤ Condenser probe enabled (P5=1)

The fans are always active if the compressor is switched on. If the compressor is switched off they are only activated if the condenser probe value is above the parameter F46 + the differential of 2°C/4°F. They are deactivated if the temperature is below the F46 parameter.

➤ Condenser probe not enabled (P5=0)

The condenser fans are only active if the compressor is active. They are deactivated with a delay set by parameter F47, when the condenser is deactivated.

➤ Condenser probe enabled but faulty

The condenser fans are activated if the compressor is activated and they are deactivated with a delay set by parameter F47.

➤ Defrosting

The fans are managed according to the value set by parameter F48 (on or off).

11.7 Alarm output management

This function is only available if one of the relays is configured as alarm.

This activates when an alarm is set off and deactivates when the alarm stops.

11.8 Needle probe heating management

This function is only available if one of the relays is configured as needle probe heating.

This output is activated by the user when the needle probe has to be removed from the blast chilled product. The output remains active until the temperature indicated by the needle probe reaches the value set by parameter u7. If within the time period set by parameter u8 this temperature is not reached, the needle probe heating function is deactivated. The door must be open during needle probe heating.

The needle probe heating function can be deactivated by setting parameter u8 to 0.

11.9 Cabinet sterilisation management

This function is only available if one of the relays is configured as cabinet sterilisation.

During a sterilisation cycle the door must be closed and the output activates for the time period set by parameter u6.

Ventilation can also be activated by setting parameter u11 to 1.

11.10 Defrost output management

This function is only available if one of the relays is configured as defrost

During defrosting outputs are managed according to the type of defrost set by parameter d1.

The defrost output will be activated regardless of the value of parameter d1 for the entire duration of the defrost.

11.11 Thawing heater management

This function is only available if one of the relays is configured as thawing.

These are activated during thawing to bring the cabinet temperature to the set point value. Heaters have a neutral zone adjustment.

11.12 Proofing and slow cooking heater management

This function is only available if one of the relays is configured as cooking and slow cooking heater

Proofing

When the temperature falls below the neutral zone relative threshold (heating), the heaters will be activated until the neutral zone temperature is restored. The heaters are activated as ON and OFF cycles given by parameters rH14 and rH15.

Slow cooking

The heaters are activated to bring the temperature to the set point value.

11.13 Humidifier management

This function is only available if one of the relays is configured as steam injection.

This function is activated on the basis of the humidity percentage set. For example, if this is set at 60%, the output is activated for 60% of the time set by parameter rU3 and deactivated for the time set by rU2 – rU3. The ON and OFF humidifying cycle repeats itself until the phase is finished.

11.14 Humidifying/steam generator heater management

This function is only available if one of the relays is configured as steam generator or cabinet heater.

This function is activated at the beginning of a cycle for which humidifying is required and it remains active for the entire duration of the cycle.

11.15 Cabinet light management

This function is only available if one of the relays is configured as cabinet light.

If present, the light comes on when the door is opened and switches off when it is closed.

12 SETTINGS

The SETTINGS are accessed by pressing area  on the Home page. The page displays the following menu:

- time and date;
- service;
- internal values;
- select language;

12.1 Time and date

Access the "time and date" area to change the device date and time. Time and date format can be configured in the 24h mode (with date displayed as dd/mm/yyyy) or in the a.m/p.m mode (with date displayed as mm/dd/yyyy).

12.2 Service

This area grants access to the following functions:

- configure parameters, using password -19
- restore default values (as in the parameter table in Chapter 14), using password 149.
- restore OEM recipes, using password 99.

12.3 Internal values

The INTERNAL VALUES area displays the list of available functions, as follows.

- alarms
- input and output status
- compressor operating hours
- set date/time
- select HACCP data
- reset internal values

From the "reset internal values" menu (which can be accessed using password 19), the following data can be reset:

- compressor operating hours
- HACCP alarms
- user recipes

12.4 Select language

Press this area to select the desired language among the pre-set ones.

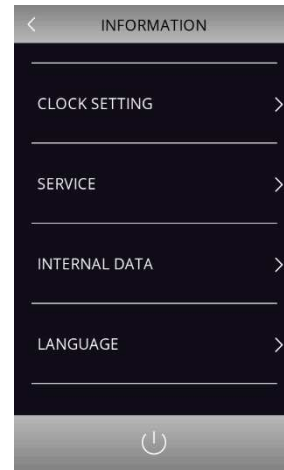

For further details on the procedure for inserting additional languages, please contact the EVCO sales network.

13 USING THE USB PORT

13.1 Initial information

The USB port makes possible the following operations.

- upload and download settings of "MY COOKBOOK" recipes and of "Special cycles" working cycles (hereinafter referred to as "programs");
- upload and download configuration parameter settings;
- download historical HACCP information.

These operations are guaranteed by using an EVCO EVUSB4096M USB device.

Uploading operations are only possible if the firmware of the device from which it originates and the firmware of the destination device(s) are the same. This information is available in the SERVICE page.

13.1.1 Uploading program settings (USB → controller)

To upload the settings of the programs, operate as follows:

1. Make sure the device is in stand-by and no procedure is underway;
2. Insert the USB flash drive into the USB port and wait until the menu is displayed;
3. Touch "UPLOAD PROGRAMS";
4. When the upload is complete, remove the USB flash drive from the device USB port.

13.1.2 Downloading program settings (controller -> USB)

To download the settings of the programs, operate as follows:

1. Make sure the device is in stand-by and no procedure is underway;
2. Insert the USB flash drive into the USB port and wait until the menu is displayed;
3. Touch "DOWNLOAD PROGRAMS";
4. When the upload is complete, remove the USB flash drive from the device USB port.

13.1.3 Uploading configuration parameter settings (USB → controller)

To upload the settings of the configuration parameter, operate as follows:

1. Make sure the device is in stand-by and no procedure is underway;
2. Insert the USB flash drive into the USB port and wait until the menu is displayed;
3. Touch "UPLOAD PARAMETERS";
4. When the upload is complete, remove the USB flash drive from the device USB port.

13.1.4 Downloading configuration parameter settings (controller -> USB)

To download the settings of the configuration parameter, operate as follows:

1. Make sure the device is in stand-by and no procedure is underway;
2. Insert the USB flash drive into the USB port and wait until the menu is displayed;
3. Touch "DOWNLOAD PARAMETERS";
4. When the upload is complete, remove the USB flash drive from the device USB port.

13.1.5 Downloading HACCP data (controller -> USB)

To download the HACCP data, operate as follows:

1. Make sure the device is in stand-by and no procedure is underway;
2. Insert the USB flash drive into the USB port and wait until the menu is displayed;
3. Touch "DOWNLOAD HACCP DATA";
4. Select date and hour of start for historical data recording ;
5. Touch  to confirm. A file named "haccp.csv" will be generated;
6. When the download is complete, remove the USB flash drive from the device USB port.

If the language in use is not a Western alphabetic language, data are saved in English in the "haccp.csv" file.

14 EPOCA CLOUD PLATFORM

EPoCA is a remote monitoring system based on a cloud platform. All that is needed is a simple onsite Wi-Fi internet connection to enable the controller, using EVlink Wi-Fi module, to connect to the cloud system, making it possible to remotely manage equipment from a PC, tablet or smartphone.

The responsive design and the graphic interface conceived to provide a pleasant user experience make EPoCA a ready-to-use solution for easily accessible monitoring operations, even for entry-level users, while offering all the typical functions of professional platforms.

With appropriate protection measures for access and data, the system makes it possible for one or more enabled users to operate remotely on the unit to configure its parameters, view HACCP data (also in graphic form) and to download records in the most popular formats, such as XLSX, CSV and PDF. The functions playing a key role include alarm warnings sent automatically by the system to selected e-mail addresses.

Schematic diagram:

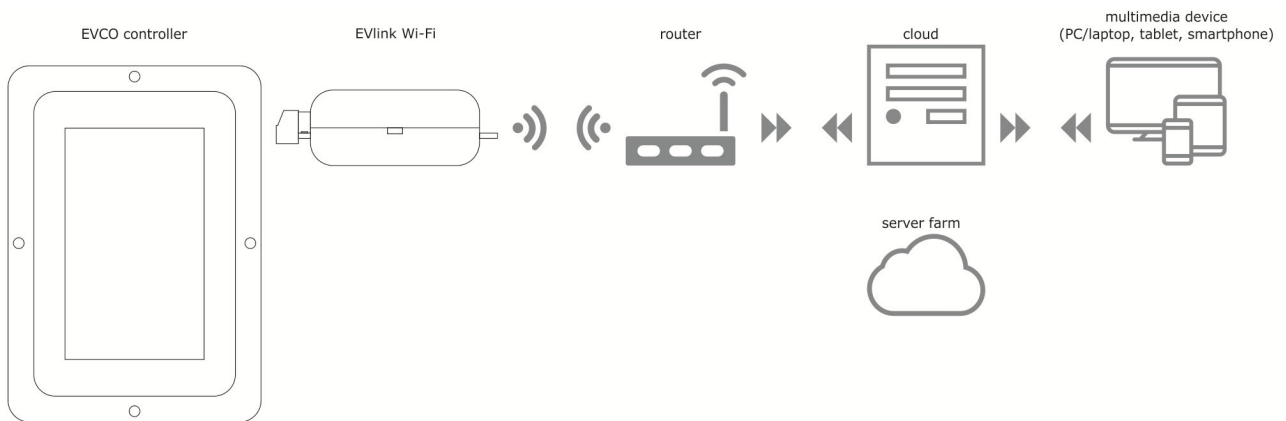

For more details on the EVlink Wi-Fi module and on the EPoCA cloud platform, please check out the "EPoCA" manual in our website www.evco.it.

15 LIST OF CONFIGURATION PARAMETERS

The following table gives the meaning of the configuration parameters.

N.B. Because some functions are managed according to the value set for some parameters, ensure these are set correctly and consistently.

PAR.	DEFAULT	MIN.	MAX.	U.M.	ANALOGUE INPUTS
CA1	0	-25	25	°C/°F ⁽¹⁾	Cabinet probe calibration
CA2	0	-25	25	°C/°F ⁽¹⁾	Evaporator probe calibration (if P4=1)
CA3	0	-25	25	°C/°F ⁽¹⁾	Condenser probe calibration (if P5=1)
CA4	0	-25	25	°C/°F ⁽¹⁾	Needle probe 1 calibration
CA5	0	-25	25	°C/°F ⁽¹⁾	Needle probe 2 calibration (if P9>1)
CA6	0	-25	25	°C/°F ⁽¹⁾	Needle probe 3 calibration (if P9>1)
P0	0	0	1	----	Type of probe 0 = PTC 1 = NTC
P2	0	0	1	----	Temperature measurement unit 0 = °C 1 = °F
P3	1	0	3	----	Type of needle probe 0 = not enabled 1 = single probe 2 = multineedle probe 3 = multi-sensor probe See also P9
P4	1	0	1	----	Enable evaporator probe 0 = no 1 = yes
P5	1	0	1	----	Enable condenser probe 0 = no 1 = yes
P9	3	1	3	----	If P3=1, P9 must be set to 1 If P3=2, the number set for P9 corresponds to the number of needle probes present (from 1 to 3) If P3 = 3, the number set for P9 corresponds to the number of sensors in the needle probe

PAR.	DEFAULT	MIN.	MAX.	U.M.	MAIN REGULATOR
r0	2	1	15	°C/°F ⁽¹⁾	Cabinet set point differential in blast chilling, blast-freezing, sanitation, ice cream hardening and customized cycles.
r1	90	1	500	min	Duration of time controlled blast chilling
r2	240	1	500	min	Duration of time controlled blast-freezing
r3	3	-50	99	°C/°F ⁽¹⁾	Product temperature to end temperature controlled blast chilling and to end the soft phase in temperature controlled soft blast-freezing. See also parameter r5
r4	-18	-50	99	°C/°F ⁽¹⁾	Product temperature to end temperature controlled blast-freezing. See also parameter r6.
r5	90	1	500	min	Maximum permitted duration for temperature controlled blast chilling. See also parameter r3
r6	240	1	500	min	Maximum permitted duration for temperature controlled blast-freezing. See also parameter r4
r7	0	-50	99	°C/°F ⁽¹⁾	Cabinet temperature set point during blast chilling and the soft phase of soft blast-freezing. See also parameter r0
r8	-40	-50	99	°C/°F ⁽¹⁾	Cabinet temperature set point during blast-freezing and ice cream hardening. See also parameter r0.
r9	-20	-50	99	°C/°F ⁽¹⁾	Cabinet temperature set point during the hard phase of hard blast chilling. See also parameter r0.
r10	2	-50	99	°C/°F ⁽¹⁾	Cabinet temperature set point during conservation after blast chilling, hard blast chilling and continuous cycle. See also parameter r0
r11	-20	-50	99	°C/°F ⁽¹⁾	Cabinet temperature set point during conservation after blast-freezing and soft blast-freezing. See also parameter r0
r12	5	-50	99	°C/°F ⁽¹⁾	Cabinet temperature set point during pre-cooling. See also parameter r0
r13	15	-50	99	°C/°F ⁽¹⁾	Product temperature to end the hard phase of hard temperature controlled blast chilling.
r14	60	10	100	%	Duration of the hard phase of hard time controlled blast chilling (i.e. the percentage of the value set by parameter r1). Duration of the soft phase of time controlled soft blast-freezing (i.e. the percentage of the value set by parameter r2)
r15	65	-50	199	°C/°F ⁽¹⁾	Product temperature below which the count for maximum duration begins for temperature controlled blast chilling or blast-freezing.
r17	5	0	99	°C/°F ⁽¹⁾	Minimum gap between the product and cabinet temperatures, according to which the first phase of the test for correct insertion of the needle probe is considered successfully completed 0 = the test is disabled and the needle probe is considered always inserted
r18	80	10	999	s	Duration of the second phase of the test for correct insertion of the needle probe.
r19	-40	-50	+99	°C/°F ⁽¹⁾	Cabinet temperature set point for the first phase of sanitation.

r20	-20	-50	99	°C/°F ⁽¹⁾	Product temperature set point for the first phase of sanitation and cabinet temperature set point for the second phase of sanitation.
r21	24	0	24	h	Duration of second sanitation phase.
r22	-20	-50	99	°C/°F ⁽¹⁾	Cabinet temperature set point for the third phase of sanitation.
r23	5	1	99	h	Maximum duration of the first sanitation phase.
r24	10	1	400	min	Duration of ice cream hardening cycle.
r25	25	-50	99	°C/°F ⁽¹⁾	Initial cabinet temperature set point for light-load thawing.
r26	30	-50	99	°C/°F ⁽¹⁾	Initial cabinet temperature set point for medium-load thawing.
r27	35	-50	99	°C/°F ⁽¹⁾	Initial cabinet temperature set point for heavy-load thawing.
r28	10	-50	99	°C/°F ⁽¹⁾	Final cabinet temperature set point for light-load thawing.
r29	12	-50	99	°C/°F ⁽¹⁾	Final cabinet temperature set point for medium-load thawing.
r30	15	-50	99	°C/°F ⁽¹⁾	Final cabinet temperature set point for heavy-load thawing.
r31	3	-50	99	°C/°F ⁽¹⁾	Cabinet temperature set point for post-thawing conservation.
r32	240	1	999	min	Light-load thawing duration.
r33	480	1	999	min	Medium-load thawing duration.
r34	720	1	999	min	Heavy-load thawing duration.
r35	-15	-50	99	°C/°F ⁽¹⁾	Cabinet temperature set point for customized blast chilling.
r36	10	-50	99	°C/°F ⁽¹⁾	Product temperature set point for customized blast chilling.
r37	240	1	999	min	Duration of time controlled customized blast chilling.
r38	5	-50	99	°C/°F ⁽¹⁾	Cabinet temperature set point for conservation after customized blast chilling.
r39	80	-50	99	°C/°F ⁽¹⁾	Maximum cabinet temperature set-point that can be set
PAR.	DEFAULT	MIN.	MAX.	U.M.	COOLING REGULATOR (parameters only valid if E12=2 or 3)
rC0	2	1	15	°C/°F ⁽¹⁾	Parameter rC3 differential.
rC3	5	-50	99	°C/°F ⁽¹⁾	Cabinet temperature set point for blast chilling phase (for proofing cycle).
rC4	1	0	10	°C/°F ⁽¹⁾	Neutral zone relative threshold (cooling) for all proofing phases.
rC5	5	-50	++	°C/°F ⁽¹⁾	Cabinet temperature set point for conservation phase in the retarding proofing cycle
PAR.	DEFAULT	MIN.	MAX.	U.M.	HEATING REGULATOR (parameters only valid if E12=2 or 3)
rH0	2	1	15	°C/°F ⁽¹⁾	Parameter rH3, rH4, rH5, rH10 and rH13 differential.
rH3	20	-50	99	°C/°F ⁽¹⁾	Cabinet temperature set point for re-awakening phase.

rH4	30	-50	99	°C/°F ⁽¹⁾	Cabinet temperature set point for proofing phase.
rH5	25	-50	99	°C/°F ⁽¹⁾	Cabinet temperature set point for holding phase.
rH6	1	0	10	°C/°F ⁽¹⁾	Neutral zone relative threshold (heating) for all proofing phases.
rH7	120	0	999	Min	Blast chilling phase duration (for proofing cycle).
rH8	240	0	999	Min	Re-awakening phase duration.
rH9	180	0	999	Min	Proofing phase duration.
rH10	80	-50	99	°C/°F ⁽¹⁾	Cabinet temperature set point for slow cooking.
rH11	60	-50	99	°C/°F ⁽¹⁾	Product temperature set point for slow cooking.
rH12	60	0	999	Min	Slow cooking duration.
rH13	60	-50	99	°C/°F ⁽¹⁾	Cabinet temperature set point for holding.
rH14	45	1	600	s	Heater cycle time for proofing.
rH15	4	1	10	s	Heater on time for proofing.
rH16	1	0	10	°C/°F ⁽¹⁾	Neutral zone relative threshold for thawing.
rH17	2	1	15	°C/°F ⁽¹⁾	Cabinet set point differential for activating heater during thawing.
rH18	2	1	15	°C/°F ⁽¹⁾	Cabinet set point differential for activating compressor during thawing.
rH19	45	1	600	s	Heater cycle time for thawing.
rH20	4	1	10	s	Heater on time for thawing.
rH21	1	0	10	°C/°F ⁽¹⁾	Neutral zone threshold for the conservation phase
PAR.	DEFAULT	MIN.	MAX.	U.M.	HUMIDITY REGULATOR (parameters only valid if E12=1)
rU1	0	-50	99	°C/°F ⁽¹⁾	Cabinet temperature under which humidifying is inhibited.
rU2	60	1	600	s	Cycle time for switching on humidifier for proofing and slow cooking.
rU3	30	1	600	s	Humidifier on time within the rU2 cycle time for generating 100% humidity in the cabinet.
rU4	0	0	1	----	Enable humidifying control during blast chilling phase (for proofing cycle) 0 = no 1 = yes
rU5	60	0	100	%	Pre-set % humidifying for blast chilling (for proofing cycle), if parameter rU4=1.
rU6	60	0	100	%	Pre-set % humidifying during conservation (retarding proofing cycle)
rU7	80	0	100	%	Pre-set % humidifying during awakening

rU8	80	0	100	%	Pre-set % humidifying during proofing
rU9	80	0	100	%	Pre-set % humidifying during holding
rU10	80	0	100	%	Pre-set % humidifying during slow cooking.
rU11	80	0	100	%	Pre-set % humidifying during holding after slow cooking.
PAR.	DEFAULT	MIN.	MAX.	U.M.	COMPRESSOR PROTECTION
C0	0	0	240	min	Minimum time between restoration of power supply after a power failure happening during an operating cycle and compressor switch-on.
C2	3	0	240	min	Minimum time between compressor switch-off and subsequent switch-on.
C3	0	0	240	min	Minimum compressor-on time.
C4	10	0	240	min	Compressor-off time during cabinet probe error (" CABINET PROBE " code) happening during conservation after blast chilling and blast-freezing. See also parameters C5 and C9
C5	10	0	240	min	Compressor-on time during cabinet probe error (" CABINET PROBE " code) happening during conservation after blast chilling. See also parameter C4.
C6	80	0	199	°C/°F ⁽¹⁾	Condenser temperature above which the condenser overheating alarm is activated (" COND OVERHEAT " code).
C7	90	0	199	°C/°F ⁽¹⁾	Condenser temperature above which the compressor locked alarm is activated (" COMP LOCKED " code), once the time set for C8 has elapsed.
C8	1	0	15	min	Activation delay of the compressor locked alarm (" COMP LOCKED " code) due to threshold C7 exceeded.
C9	30	0	240	min	Compressor-on time during cabinet probe error (" CABINET PROBE " code) happening during conservation after blast-freezing. See also parameter C4
C10	5	1	240	s	Compressor switch-on delay (if at least one relay is configured as compressor 2)
PAR.	DEFAULT	MIN.	MAX.	U.M.	DEFROSTING
d0	8	0	99	h	Defrost interval 0 = defrost at intervals is never activated.
d1	1	0	4	- - - -	Type of defrost 0 = electrical (during defrosting the compressor is switched off, the defrost output is activated and the evaporator fan switched off). 1 = hot gas (during defrosting the compressor is switched on, the defrost output is activated and the evaporator fan is switched off). 2 = air (during defrosting the compressor is switched off and the defrost output is activated. The evaporator fan is switched on, regardless of the door status, or regardless of the status of the door switch input) 3 = air with the door open (during defrosting the compressor is switched off and the defrost output is activated. The evaporator fan is switched on, provided the door is open or provided the door switch input is on and that

					parameter i0 is set to a value other than 0).
d2	2	-50	99	°C/°F ⁽¹⁾	Evaporator temperature to end defrosting. See also parameter d3
d3	30	0	99	min	If the evaporator probe is not present (P4=0), it sets the defrost duration. If the evaporator probe is present (P4=1), it sets the maximum defrost duration. See also parameter d2 0 = defrost is never activated.
d4	0	0	1	----	Enable defrost at the start of blast chilling and of blast-freezing 0 = no 1 = yes
d5	30	0	99	min	Defrost delay from the beginning of conservation 0 = defrost will be activated once the time set by d0 has elapsed.
d7	2	0	15	min	Drip time after a defrost, in which the compressor and the evaporator fan are switched off and the defrost output is deactivated.
d15	0	0	99	min	Minimum consecutive compressor-on duration for starting hot gas defrost, if d1 is set to 1
d16	0	0	99	min	Pre-drip time if d1 is set to 1 (hot gas defrost), in which the compressor and the evaporator fan are off and the defrost output remains activate.
PAR.	DEFAULT	MIN.	MAX.	U.M.	TEMPERATURE ALARMS
A1	10	0	99	°C/°F ⁽¹⁾	Cabinet temperature below which the minimum temperature alarm is activated (in relation to the working set point, i.e. "r10-A1" during conservation after blast chilling and "r11-A1" during conservation after blast-freezing; (" LOW TEMPERATURE " code). See also parameter A11
A2	1	0	1	----	Enable minimum temperature alarm (" LOW TEMPERATURE " code): 0 = no 1 = yes
A4	10	0	99	°C/°F ⁽¹⁾	Cabinet temperature above which the maximum temperature alarm is activated (relating to the working set point, i.e. "r10+A4" during conservation after blast chilling and "r11+A4" during conservation after blast-freezing (" HIGH TEMPERATURE " code). See also parameter A11 (4)
A5	1	0	1	----	Enable maximum temperature alarm (" HIGH TEMPERATURE " code): 0 = no 1 = yes
A7	15	0	240	min	Temperature alarm delay (" HIGH TEMPERATURE " code and " LOW TEMPERATURE " code)
A8	15	0	240	min	Maximum temperature alarm delay (" HIGH TEMPERATURE " code) from the end of the evaporator fan-off time and from the beginning of conservation.

A10	5	0	240	min	Power failure duration sufficient for the power failure alarm to be saved ("POWER FAILURE" code) when this is restored 0 = the alarm will not be signalled
A11	2	1	15	°C/°F ⁽¹⁾	Parameter A1 and A4 differential
A12	5	0	240	s	Duration of buzzer activation on completion of blast chilling and blast-freezing.
A13	60	0	240	s	Duration of buzzer activation for an alarm event
PAR.	DEFAULT	MIN.	MAX.	U.M.	EVAPORATOR AND CONDENSER FANS
F1	-1	-50	99	°C/°F ⁽¹⁾	The evaporator temperature above which the evaporator fan switches off during pre-cooling/blast chilling/blast-freezing/sanitation/ice cream hardening/blast chilling (for proofing cycle). See also parameter F8.
F3	2	0	15	min	Duration of evaporator fan-off time (while the evaporator fan is off the compressor may be switched on, the defrost output is de-activated and the evaporator fan stays off).
F8	2	1	15	°C/°F ⁽¹⁾	Parameter F1 and F17 differential.
F15	15	0	240	s	Evaporator fan delay from when the door is closed, or the door switch input is deactivated.
F17	90	-50	199	°C/°F ⁽¹⁾	Cabinet temperature above which the evaporator fan is switched off during pre-cooling/blast chilling/blast-freezing/sanitation/ice cream hardening/blast chilling (for proofing cycle). See also parameter F8.
F19	20	0	100	%	Evaporator fan minimum speed calibration.
F20	80	0	100	%	Evaporator fan maximum speed calibration.
F21	80	0	100	%	Start-up speed.
F22	5	0	10	s	Start-up time.
F23	5	1	5	----	Fan speed during blast chilling and soft blast-freezing phase.
F24	5	1	5	----	Fan speed during hard blast chilling phase.
F25	5	1	5	----	Fan speed during blast-freezing and ice cream hardening.
F26	5	1	5	----	Fan speed during positive conservation.
F27	5	1	5	----	Fan speed during negative conservation.
F28	5	1	5	----	Fan speed during pre-cooling.
F29	1	1	5	----	Fan speed in first thawing phase.
F30	1	1	5	----	Fan speed in second thawing phase.
F31	1	1	5	----	Fan speed in third thawing phase.
F32	1	1	5	----	Fan speed in fourth thawing phase.
F33	1	1	5	----	Fan speed in fifth thawing phase.
F34	1	1	5	----	Fan speed during conservation after thawing.

F35	5	1	5	----	Fan speed in first sanitation phase (blast chilling).
F36	5	1	5	----	Fan speed in second sanitation phase (holding).
F37	5	1	5	----	Fan speed in third sanitation phase (conservation).
F38	5	1	5	----	Fan speed during customized blast chilling.
F39	5	1	5	----	Fan speed during customized conservation.
F40	5	1	5	----	Fan speed during slow cooking.
F41	5	1	5	----	Fan speed during holding after slow cooking.
F42	5	1	5	----	Fan speed during blast chilling (for proofing cycle)
F43	5	1	5	----	Fan speed during re-awakening.
F44	5	1	5		Fan speed during proofing.
F45	5	1	5		Fan speed during conservation (for proofing cycle)
F46	15	0	99	°C/°F ⁽¹⁾	Condenser temperature above which the condenser fan switches on.
F47	30	0	240	s	Condenser fan switch-off delay from when the compressor is switched off (only if the condenser probe is not present).
F48	---	0	1	0	Condenser fan status during defrosting. 0 = off 1 = on
F49	0	0	1	---	Fan operating mode during conservation 0 = parallel to the compressor 1 = always ON
F50	0	0	1	---	Fan operating mode during slow cooking 0 = always ON 1 = ON if heating elements are ON, with ON-OFF cycles if heating elements are OFF
F51	180	0	999	s	Fan OFF time during heating when operating with F50 = 1
F52	60	0	999	s	Fan ON time during heating when operating with F50 = 1
F53	1	1	5	---	Minimum fan speed that can be set for all cycles except slow cooking <u>NB: check that the value set is consistent with parameters from F23 to F45</u>
F54	1	1	5	---	Minimum fan speed that can be set for slow cooking <u>NB: check that the value set is consistent with parameters from F23 to F45</u>

PAR.	DEFAULT	MIN.	MAX.	U.M.	DIGITAL INPUTS
i0	2	0	2	----	Effect caused by the door opening, or when the door switch input is activated. 0 = no effect and no signal 1 = the compressor, evaporator fan, thawing heater, heater and humidifier are switched off and the cabinet light is on, once the time set by parameter i2 has elapsed, the device displays the alarm and the buzzer is activated until the door is closed. See also parameter F15 2 = the evaporator fan is switched off and the cabinet light is on, once the time set by parameter i2 has elapsed, the device displays the alarm and the buzzer is activated until the door is closed. See also parameter F15.
i1	0	0	1	----	Door switch input polarity 0 = normally open (input active with contact closed) 1 = normally closed (input active with contact open)
i2	5	-1	120	min	Door-open time for door-open alarm record; -1 = alarm not signalled.
i5	-	-	-	----	unused
i6	0	0	1	----	High pressure input polarity 0 = normally open (input active with contact closed) 1 = normally closed (input active with contact open)
i7	5	-1	240	s	High-pressure alarm signal delay -1 = alarm not signalled
i8	-	-	-	----	unused
i9	0	0	1	----	Low pressure input polarity 0 = normally open (input active with contact closed) 1 = normally closed (input active with contact open)
i10	5	-1	240	s	Low-pressure alarm signal delay -1 = alarm not signalled
i11	0	0	1	----	Thermal switch input polarity 0 = normally open (input active with contact closed) 1 = normally closed (input active with contact open)
i12	5	-1	240	s	Thermal switch alarm signal delay -1 = alarm not signalled
i13	-	-	-	----	unused
PAR.	DEFAULT	MIN.	MAX.	U.M.	DIGITAL OUTPUTS

u01c	1	0	12	----	Function managed by output K1 0. Unused 1. Compressor 1 2. Compressor 2 3. Defrost 4. Evaporator fan 5. Condenser fan 6. Door heater 7. Thawing heater 8. Alarm 9. Pump down valve 10. Needle probe heater 11. UV lamp 12. Cabinet light 13. Cabinet heater (only for relays from u10c to u13c) 14. Steam Generator (only for relays from da u10c to u13c) 15. Steam injection (only for relays from u10c to u13c)
u02c	3	0	12	----	Function managed by output K2 Same settings as specified under parameter u01c
u03c	4	0	12	----	Function managed by output K3 Same settings as specified under parameter u01c
u04c	5	0	12	----	Function managed by output K4 Same settings as specified under parameter u01c
u05c	6	0	12	----	Function managed by output K5 Same settings as specified under parameter u01c
u06c	7	0	12	----	Function managed by output K6 Same settings as specified under parameter u01c
u07c	8	0	12	----	Function managed by output K7 Same settings as specified under parameter u01c
u08c	9	0	12	----	Function managed by output K8 Same settings as specified under parameter u01c
u09c	10	0	12	----	Function managed by output K9 Same settings as specified under parameter u01c
u10c	13	0	15	----	Function managed by output K10 (if the expansion is present) Same settings as specified under parameter u01c
u11c	14	0	15	----	Function managed by output K11 (if the expansion is present) Same settings as specified under parameter u01c
u12c	15	0	15	----	Function managed by output K12 (if the expansion is present) Same settings as specified under parameter u01c
u13c	0	0	15	----	Function managed by output K13 (if the expansion is present) Same settings as specified under parameter u01c
u5	2	-50	99	°C/°F ⁽¹⁾	Cabinet temperature over which the door heaters are switched off
u6	5	1	240	min	Time the UV lamp is on for the sterilisation cycle

u7	40	-50	199	°C/°F ⁽¹⁾	Temperature to end needle probe heating. See also parameter u8
u8	2	0	240	min	Maximum duration of needle probe heating. See also parameter u7 0 = needle probe heating is disabled.
u9	-	-	-	----	unused
u11	0	0	1	----	Enable evaporator ventilation during sterilisation 0=no 1=yes
u12	10	0	999	s	Compressor switch-off delay from deactivation of the pump down valve (pump down being switched off)
u13	25	1	99	m	Drying duration
PAR.	DEFAULT	MIN.	MAX.	U.M.	COMUNICAZIONE SERIALE (porta seriale di tipo RS-485 con protocollo di comunicazione MODBUS) + EVLINK WIFI
L1	5	1	240	min	Data recording interval during the main cycles. The interval is the same both for the internal data-logger and for EVLINK
LA	247	1	247	----	device address
Lb	3	0	3	----	baud rate 0 = 2,400 Bd 1 = 4,800 Bd 2 = 9,600 Bd 3 = 19,200 Bb
LP	2	0	2	----	parity 0 = none 1 = odd 2 = even
PA1	426	-99	999	----	EVconnect/EPoCA level 1 password
PA2	824	-99	999	----	EVconnect/EPoCA level 2 password
bLE	1	0	99	----	Serial port connectivity configuration 0 = free 1 = forced for EVconnect or EPoCA 2-99 = EPoCA local network address
PAR.	DEFAULT	MIN.	MAX.	U.M.	MISCELLANEOUS
E7	0	0	1	----	Activate "lock keypad" function 0 = function not enabled 1 = automatic with temporary effect (60s time lapse from the time the key was pressed while a cycle is in progress, the keypad locks automatically).

E8	60	30	600	s	Time-out for keypad lock
E9	1	0	1	----	Display EVCO splash screen when power is restored 0 = no 1 = yes
E12	0	0	3	----	Enable expansion module functions 0 = no 1 = only slow cooking 2 = only retarding proofing 3 = slow cooking + retarding proofing NB: when changing this parameter, the device will be automatically restarted.
E13	0	0	1	----	Machine type 0 = Home "blast chiller" 1 = Home "multifunction" NB: when changing this parameter, the device will be automatically restarted.
E14	0	1	0	----	Operating mode when needle probe insertion test fails 0 = time-controlled 1 = needle probe
E15	0	1	0	----	Save modified OEM recipes 0 = in the user recipe book 1 = in the user recipe book + overwrite OEM recipe
E16	0	1	1	----	Ventilation mode 0 = with phase cutting 1 = without phase cutting

Notes

(1) the unit of measurement depends on parameter P2

16 ALARMS

16.1 Alarms

The table below lists the various alarms.

Code	Meaning
RTC	<p>Clock error.</p> <p>To correct</p> <ul style="list-style-type: none"> - Re-set the date and time. <p>Main consequences</p> <ul style="list-style-type: none"> - The device will not memorise the date and time an HACCP alarm happened. - The alarm output will be activated.
CABINET PROBE	<p>Cabinet probe error.</p> <p>To correct</p> <ul style="list-style-type: none"> - Check the parameter P0 value. - Check that the probe is undamaged. - Check the device-probe connection. - Check the cabinet temperature. <p>Main consequences</p> <ul style="list-style-type: none"> - If the error happens during stand-by, it will not be possible to set or start any operating cycle. - If the error happens during blast chilling or blast-freezing, the cycle will continue with the compressor in continuous mode. - If the error happens during conservation, the compressor will operate according to parameters C4 and C5 or C9. - If the error happens during a proofing, slow cooking or a thawing cycle, the cycle will be interrupted. - The minimum temperature alarm will never be activated. - The maximum temperature alarm will never be activated. - The door heaters will never be switched on. - The alarm output will be activated.
EVAPORATOR PROBE	<p>Evaporator probe error.</p> <p>To correct:</p> <ul style="list-style-type: none"> - The same as for the cabinet probe error but with reference to the evaporator probe. <p>Main consequences</p> <ul style="list-style-type: none"> - If parameter P4 is set to 1, defrosting will last for the time set by parameter d3. - Parameter F1 will have no effect. - The alarm output will be activated.

<p>CONDENSER PROBE</p>	<p>Condenser probe error.</p> <p>To correct</p> <ul style="list-style-type: none"> - The same as for the cabinet probe error but with reference to the condenser probe. <p>Main consequences</p> <ul style="list-style-type: none"> - The condenser fan will operate in parallel with the compressor. - The condenser overheat alarm will never be activated. - The compressor locked alarm will never be activated. - The alarm output will be activated.
<p>NEEDLE PROBE SENSOR 1</p>	<p>Needle probe/sensor 1 error.</p> <p>To correct</p> <ul style="list-style-type: none"> - The same as for the cabinet probe error but with reference to needle probe 1. <p>Main consequences if parameter P3 is set to 1 (single probe)</p> <ul style="list-style-type: none"> - If the error happens during stand-by, the temperature controlled cycles will be started up as time-controlled. - If the error happens during temperature controlled blast chilling, blast chilling will last for the time set by parameter r1 - If the error happens during temperature controlled blast-freezing, blast-freezing will last for the time set by parameter r2 - If the error happens during needle probe heating, the heating will be interrupted. - The alarm output will be activated. <p>Main consequences if parameter P3 is set to 2 or 3 (multineedle or multi-sensor probes)</p> <ul style="list-style-type: none"> - The device will not use the probe/sensor showing the error but the other available probes or sensors will be used.
<p>NEEDLE PROBE SENSOR 2</p>	<p>Needle probe/sensor 2 error.</p> <p>To correct</p> <ul style="list-style-type: none"> - The same as for the cabinet probe error but with reference to needle probe 2. <p>Main consequences</p> <ul style="list-style-type: none"> - The device will not use needle probe 2.
<p>NEEDLE PROBE SENSOR 3</p>	<p>Needle probe/sensor 3 error.</p> <p>To correct</p> <ul style="list-style-type: none"> - The same as for the cabinet probe error but with reference to needle probe 3. <p>Main consequences</p> <ul style="list-style-type: none"> - The device will not use needle probe 3.
<p>THERMAL SWITCH</p>	<p>Thermal switch alarm</p> <p>To correct</p> <ul style="list-style-type: none"> - Check the state of the thermal switch input. - Check the value of parameter i11. <p>Main consequences</p> <ul style="list-style-type: none"> - The cycle in progress will be interrupted - The alarm output will be activated.

<p>HIGH PRESSURE SWITCH</p>	<p>High pressure alarm.</p> <p>To correct</p> <ul style="list-style-type: none"> - Check the state of the high pressure input. - Check the value of parameter i6. <p>Main consequences</p> <ul style="list-style-type: none"> - If the cycle underway requires use of the compressor, the cycle will be interrupted. - The alarm output will be activated.
<p>LOW PRESSURE SWITCH</p>	<p>Low pressure alarm.</p> <p>To correct:</p> <ul style="list-style-type: none"> - Check the state of the low pressure input. - Check the value of parameter i9. <p>Main consequences</p> <ul style="list-style-type: none"> - If the cycle underway requires use of the compressor, the cycle will be interrupted. - The alarm output will be activated.
<p>DOOR OPEN</p>	<p>Door open alarm.</p> <p>To correct</p> <ul style="list-style-type: none"> - Check the door status. - Check the value of parameters i0 and i1. <p>Main consequences</p> <ul style="list-style-type: none"> - The effect set by parameter i0. - The alarm output will be activated.
<p>HIGH TEMPERATURE</p>	<p>Maximum temperature alarm (HACCP alarm).</p> <p>To correct</p> <ul style="list-style-type: none"> - Check the cabinet temperature. - Check the value of parameters A4 and A5. <p>Main consequences</p> <ul style="list-style-type: none"> - The device will memorise the alarm. - The alarm output will be activated.
<p>LOW TEMPERATURE</p>	<p>Minimum temperature alarm (HACCP alarm).</p> <p>To correct</p> <ul style="list-style-type: none"> - Check the cabinet temperature. - Check the value of parameters A1 and A2. <p>Main consequences</p> <ul style="list-style-type: none"> - The device will memorise the alarm. - The alarm output will be activated.
<p>CYCLE DURATION</p>	<p>Alarm indicating that temperature controlled blast chilling or blast-freezing has not been completed within the maximum duration (HACCP alarm).</p> <p>To correct</p> <ul style="list-style-type: none"> - Check the value of parameters r5 and r6. <p>Main consequences</p> <ul style="list-style-type: none"> - The device will memorise the alarm. - The alarm output will be activated.

<p>BOARD COMMUNICATIONS</p>	<p>User interface-control module communication error.</p> <p>To correct</p> <ul style="list-style-type: none"> - Check the user interface-control module connection. <p>Main consequences</p> <ul style="list-style-type: none"> - Any cycle underway will be terminated and it will not be possible to start one up.
<p>BOARD COMPATIBILITY</p>	<p>User interface-control module compatibility error.</p> <p>To correct</p> <ul style="list-style-type: none"> - Check that the user interface and the control module are compatible. <p>Main consequences</p> <ul style="list-style-type: none"> - Any cycle underway will be terminated and it will not be possible to start one up.
<p>NEEDLE PROBE</p>	<p>Needle probe alarm (all the needle probe sensors enabled are in alarm status)</p> <p>To correct</p> <ul style="list-style-type: none"> - The same as for the cabinet probe error but with reference to all the needle probes. <p>Main consequences</p> <ul style="list-style-type: none"> - Any temperature controlled cycle will be interrupted
<p>POWER FAILURE</p>	<p>Power failure alarm (HACCP alarm).</p> <p>To correct</p> <ul style="list-style-type: none"> - Check the device-power supply connection. <p>Main consequences:</p> <ul style="list-style-type: none"> - The device will memorise the alarm. - Any cycle underway will resume when power is restored. - The alarm output will be activated.
<p>SANITATION PROBE INSERTION</p>	<p>Sanitation alarm.</p> <p>To correct</p> <ul style="list-style-type: none"> - Check that the needle probe has been correctly inserted and check the value of parameters r17 and r18. <p>Main consequences</p> <ul style="list-style-type: none"> - The sanitation cycle will be interrupted.
<p>SANITATION DURATION</p>	<p>Alarm indicating that sanitation has not been completed within the maximum duration (HACCP alarm).</p> <p>To correct</p> <ul style="list-style-type: none"> - Check the value of parameter r23 <p>Main consequences</p> <ul style="list-style-type: none"> - The device will memorise the alarm. - The cycle underway will be interrupted. - The alarm output will be activated.
<p>CONDENSER OVERHEAT</p>	<p>Condenser overheat alarm.</p> <p>To correct</p> <ul style="list-style-type: none"> - Check the condenser temperature. - Check the value of parameter C6. <p>Main consequences</p> <ul style="list-style-type: none"> - The condenser fan will be switched on. - The alarm output will be activated.

<p>COMPRESSOR LOCKED</p>	<p>Compressor locked alarm.</p> <p>To correct</p> <ul style="list-style-type: none"> - Check the condenser temperature - Check the value of parameter C7 - Disconnect the device from the power supply and clean the condenser. <p>Main consequences</p> <ul style="list-style-type: none"> - If the error happens during "stand-by", it will not be possible to select or start up an operating cycle. - If the error happens during an operating cycle, the cycle will be interrupted. - The alarm output will be activated.
<p>NEEDLE PROBE INSERTION</p>	<p>Needle probe not inserted alarm.</p> <p>To correct</p> <ul style="list-style-type: none"> - Check that the needle probes have been correctly inserted and check the value of parameters r17 and r18. <p>Main consequences</p> <ul style="list-style-type: none"> - The temperature controlled cycle in progress will be converted to a time controlled cycle.
<p>EXPANSION COMMUNICATIONS</p>	<p>User interface-expansion module communication error.</p> <p>To correct</p> <ul style="list-style-type: none"> - Check the user interface-expansion module connection. <p>Main consequences</p> <ul style="list-style-type: none"> - Any proofing or slow cooking cycle underway will be terminated and it will not be possible to start one up.
<p>EXPANSION COMPATIBILITY</p>	<p>User interface-expansion module compatibility error.</p> <p>To correct</p> <ul style="list-style-type: none"> - Check the user interface and expansion module are compatible. <p>Main consequences</p> <ul style="list-style-type: none"> - Any cycle underway will be terminated and it will not be possible to start one up.

16.2 HACCP alarms

To access the HACCP alarm area, press area  in the Home screen. The screen below will be displayed.



The following HACCP alarms are listed.

- Blast chilling/blast-freezing cycle duration
- Power failure
- Door open
- High temperature alarm
- Low temperature alarm

17 ACCESSORIES

17.1 EVC20P52N9XXX10 - Multi-functional module

The module makes it possible to add to the controller's potential functions, enabling special cycles to be managed with control of heating and steam generation and injection.



17.2 ECTSFD004 - 230 VAC/12 VAC 20 VA safety transformer

The transformer can power the controller user interface.



17.3 EVIF20SUXI - Non-optoisolated RS-485/USB serial interface

The interface enables the controller to be connected to the Parameters Manager set-up software system.



17.4 081200002 - USB plug for panel installation

This plug makes the controller's USB port more accessible.

To connect the plug to the USB port, connecting cable 0810500018 or 0810500020 must be used (to be ordered separately).



17.5 0810500018/0810500020 - Connecting cables

These cables are used to connect the USB plug for panel installation 081200002 to the controller's USB port.

Cable 0810500018 is 2 m long; cable 0810500020 is 0.5 m long.



17.6 EVDFAN1 - Phase cutting speed regulator for single-phase fans

The regulator can vary the evaporator fan speed, to manage the blast chilling intensity.

The maximum operating current is 5 A.



17.7 EVUSB4096M - 4GB USB flash drive

This flash drive makes it possible to upload and download the controller configuration and the customized cycles saved by the user. HACCP data can also be exported in CSV format.



17.8 EVIF25SWX – EVlink Wi-Fi RS485 module

Through the RS-485 communications port, the module provides the controller with Wi-Fi connectivity which enables remote management and monitoring from the Internet using the EPoCA cloud system.



18 TECHNICAL SPECIFICATIONS

18.1 Technical specifications

Purpose of the control device	Function controller.	
Construction of the control device	Built-in electronic device.	
Container	user interface	control module
	Open frame board behind glass.	Open frame board.
Category of heat and fire resistance	D.	
Measurements	user interface	control module
	Vcolor 869M: 118.0 x 166.0 x 35 mm (4.645 x 6.535 x 1.377 in; L x H x D) Vcolor 869L: 156.0 x 216.0 x 50.0 mm (6.141 x 8.503 x 1.968 in; L x H x D)	166.0 x 116.0 x 44.0 mm (6.535 x 4.566 x 1.732 in; L x H x D).
Mounting methods for the control device	user interface	control module
	Installed from behind using threaded studs.	On a flat surface with spacers.
Degree of protection	user interface	control module
	IP65 (front).	IP00.
Connection methodjgv y96	user interface	control module
	Plug-in screw terminal blocks for wires up to 1.5 mm ² , type A female USB connector.	Plug-in screw terminal blocks for wires up to 2.5 mm ² .
	Maximum permitted length for connecting cablesy - user-interface-control module connection: 10 m (32.8 ft) - power supply: 10 m (32.8 ft) - analogue inputs: 10 m (32.8 ft) - digital inputs: 10 m (32.8 ft) - analogue outputs: 1 m (3.28 ft) - digital outputs: 100 m (328 ft) - RS-485 MODBUS port: 1,000 m (3,280 ft) - USB port: 1 m (3.28 ft).	
Operating temperature	From 0 to 55 °C (from 32 to 131 °F)	
Storage temperature	From -10 to 70 °C (from 14 to 158 °F)	
Operating humidity	Relative humidity without condensate from 10 to 90%.	
Pollution status of the control device	2.	

Environmental standards	<ul style="list-style-type: none"> - RoHS 2011/65/EC - WEEE 2012/19/EU - REACH (EC) Regulation no. 1907/2006. 	
EMC standards	<ul style="list-style-type: none"> - EN 60730-1 - IEC 60730-1. 	
Power supply	user interface	control module
	<p>Vcolor 869M (5"): powered by the control module.</p> <p>Vcolor 869L (7"): powered by an external transformer 12 VAC ($\pm 15\%$), 50/60 Hz (± 3 Hz), max. 10 VA.</p>	115... 230 VAC ($\pm 15\%$), 50/60 Hz (± 3 Hz), 10 VA max.
Rated impulse-withstand voltage	4 KV.	
Over-voltage category	III.	
Software class and structure	A.	
Clock	Built-in (with secondary lithium battery).	
	Clock drift: ≤ 60 s/month at 25 °C (77 °F).	
	Clock battery autonomy in the absence of a power supply: > 6 months at 25 °C (77 °F).	
	Clock battery charging time: 24 h (the battery is charged by the power supply of the device).	
Analogue inputs	6 for PTC or NTC probes (cabinet probe, needle probe with up to 3 sensors, evaporator probe and condenser probe).	
	<i>PTC probes</i>	
	Sensor type:	KTY 81-121 (990 Ω @ 25 °C, 77 °F).
	Measurement field:	from -50 to 150 °C (from -58 to 302 °F).
Resolution:	1 °C (1 °F).	
Analogue inputs	<i>NTC probes</i>	
	Sensor type:	$\beta 3435$ (10 K Ω @ 25 °C, 77 °F).
	Measurement field:	from -40 to 105 °C (from -40 to 221 °F)
	Resolution:	1 °C (1 °F).
Digital inputs	4, dry contact (door switch, compressor thermal switch, low and high pressure switch).	
	<i>Dry contact</i>	
	Contact type:	5 VDC, 2 mA.
	Power feed:	none.
Analogue outputs	1 for PWM signal (for phase cutting speed regulator for single-phase EVDFAN1 fans).	

Digital outputs	9, electro-mechanical relays The maximum permitted current on loads 3 and 4 is 10 A, on load K1 is 20 A (see the electrical circuit diagram). The relays do not manage LED and fluorescent lamps
	Compressor relay: 30 A SPST res. @ 250 VAC.
	Defrost relay: 8 A SPST res. @ 250 VAC.
	Evaporator fan relay: 8 A SPST res. @ 250 VAC.
	Condenser fan relay: 8 A SPST res. @ 250 VAC.
	Door heater relay: 8 A SPDT res. @ 250 VAC.
	Door heater relay: 16 A SPST res. @ 250 VAC.
	Auxiliary relay 1: 16 A SPST res. @ 250 VAC.
	Auxiliary relay 2: 8 A SPST res. @ 250 VAC.
	Auxiliary relay 3: 8 A SPST res. @ 250 VAC.
Type 1 or Type 2 Actions	Type 1.
Additional features of Type 1 or Type 2 actions	C.
Displays	7 or 5-inch capacitive TFT touch-screen graphic display, 65K colours, 800 x 480 pixel resolution. The presence of point defects on the display falls within the tolerance limits as provided by applicable standards.
Alarm buzzer	Built-in.
Communications ports	<ul style="list-style-type: none"> - 1 RS-485 MODBUS port - 1 USB port

Vcolor 869

Controller for blast chillers
with customizable graphical skin

Installer manual ver. 1.0

GA - 11/20

Code 144VC869E104

This document is the exclusive property of EVCO and any reproduction or disclosure is absolutely prohibited unless expressly authorised by EVCO.

EVCO accepts no liability for the features and technical data described in this document and for any errors it may contain or that can arise from its use.

EVCO may not be held liable for any damage caused by failure to follow the instructions described in this document.

EVCO reserves the right to make any modifications to this document without prior warning and at any time, without prejudice to the essential aspects of functionality and safety.



EVCO S.p.A.

Via Feltre 81, 32036 Sedico Belluno ITALIA

Tel. 0437 / 8422

Fax 0437 / 83648

info@evco.it

www.evco.it